

HARDWARE

for Bathrooms



Bohle Bilbao Premium Shower Door Hinges

The Bilbao Premium shower door hinge series combines modern, square design with useful technical details. Thanks to its versatility and functionality as well as its outstanding price/performance ratio, the Bilbao Premium range is popular with builders, planners and architects. Bilbao Premium is equipped with a self-closing function starting from an opening angle of approx. $\pm 15^\circ$. Outside this range, the hinge can stop in any position. In addition, the Bilbao Premium benefits from an adjustable zero position, making the alignment of the door much easier for installers.



Shower Door Hinge Bilbao Premium HD glass/wall 90°, one side wall mounted



FINISH	ART. NO.
shiny chrome-plated	BO 5211563
stainless steel look	BO 5211564
max. door weight per pair	50 kg
max. door height	2000 mm
max. door width	1000 mm
material	brass

i Glass thickness 8, 10, 12 mm · Self-closing from 15° · Continuously adjustable zero position · Supplied without mounting hardware

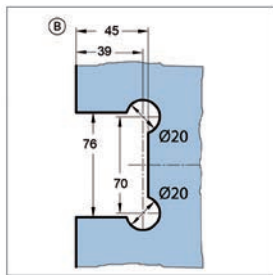
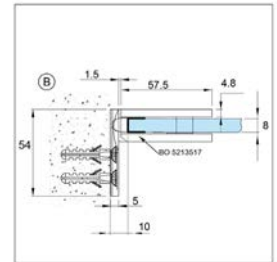
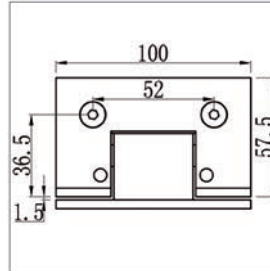

Shower Door Hinge Bilbao Premium glass / wall 90°, one side wall mounted



FINISH	ART. NO.
shiny chrome-plated	BO 5211553
stainless steel look	BO 5211554
max. door weight per pair	40 kg
max. door height	2000 mm
max. door width	1000 mm
material	brass

i Glass thickness 8, 10, 12 mm · Self-closing from 15° · Continuously adjustable zero position · Supplied without mounting hardware

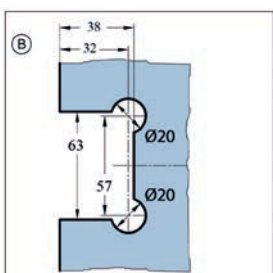
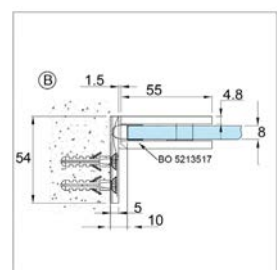
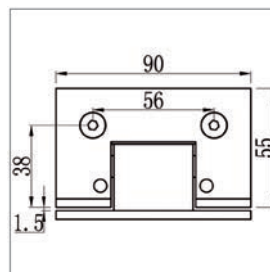

Shower Door Hinge Bilbao Premium HD glass / wall 90°, both sides wall mounted



FINISH	ART. NO.
shiny chrome-plated	BO 5211561
stainless steel look	BO 5211562
max. door weight per pair	50 kg
max. door height	2000 mm
max. door width	1000 mm
material	brass

① Glass thickness 8, 10, 12 mm · Self-closing from 15° · Continuously adjustable zero position · Supplied without mounting hardware

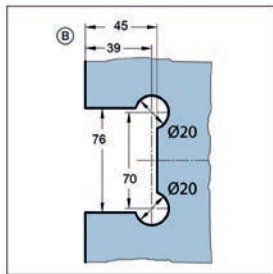
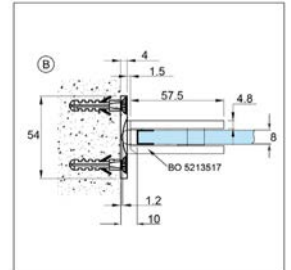
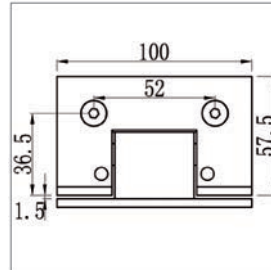

Shower Door Hinge Bilbao Premium glass / wall 90°, both sides wall mounted



FINISH	ART. NO.
shiny chrome-plated	BO 5211551
stainless steel look	BO 5211552
max. door weight per pair	40 kg
max. door height	2000 mm
max. door width	1000 mm
material	brass

① Glass thickness 8, 10, 12 mm · Self-closing from 15° · Continuously adjustable zero position · Supplied without mounting hardware

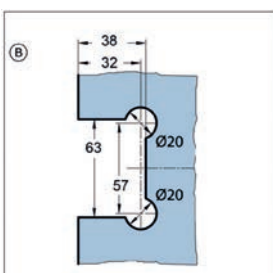
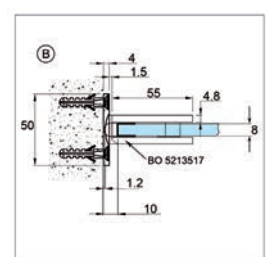
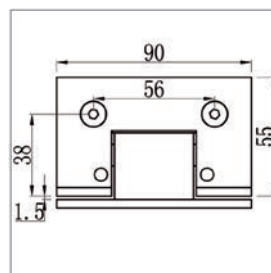

Shower Door Hinge Bilbao Premium glass/glass 90°



FINISH	ART. NO.
shiny chrome-plated	BO 5211557
stainless steel look	BO 5211558
max. door weight per pair	40 kg
max. door height	2000 mm
max. door width	1000 mm
material	brass

i Glass thickness 8, 10, 12 mm · Self-closing from 15° · Continuously adjustable zero position

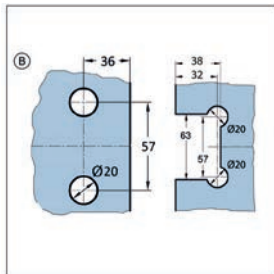
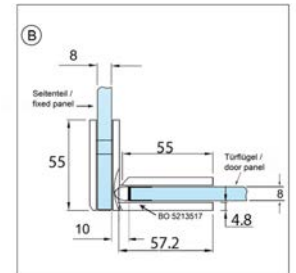
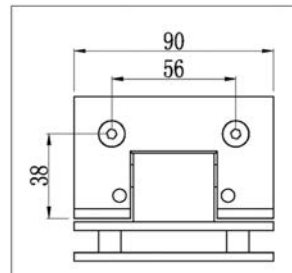

Shower Door Hinge Bilbao Premium HD glass/glass 180°



FINISH	ART. NO.
shiny chrome-plated	BO 5211565
stainless steel look	BO 5211566
max. door weight per pair	50 kg
max. door height	2000 mm
max. door width	1000 mm
material	brass

i Glass thickness 8, 10, 12 mm · Self-closing from 15° · Continuously adjustable zero position

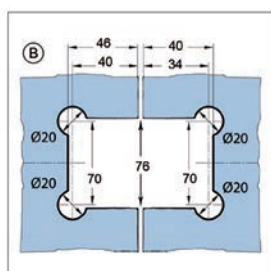
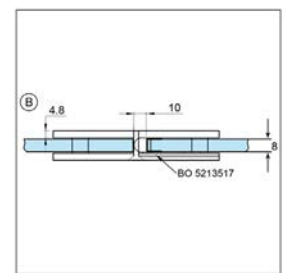
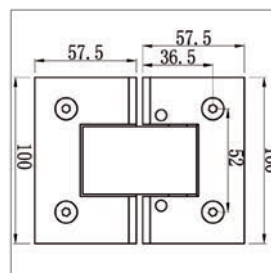

Shower Door Hinge Bilbao Premium glass/glass 180°



FINISH	ART. NO.
shiny chrome-plated	B0 5211555
stainless steel look	B0 5211556
max. door weight per pair	40 kg
max. door height	2000 mm
max. door width	1000 mm
material	brass

i Glass thickness 8, 10, 12 mm · Self-closing from 15° · Continuously adjustable zero position

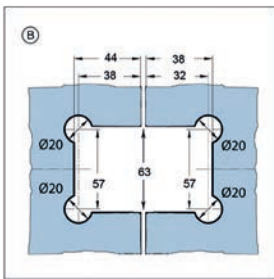
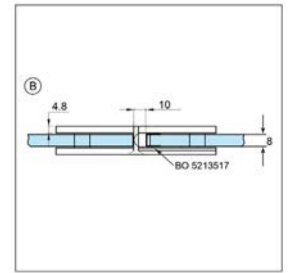
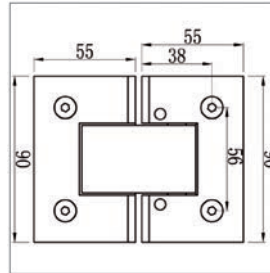

Corner Clamp Bilbao Premium HD glass/wall 90°



FINISH	ART. NO.
shiny chrome-plated	B0 5211567N
stainless steel look	B0 5211568N
max. door weight per pair	– kg
max. door height	– mm
max. door width	– mm
material	brass

i Glass thickness 8, 10, 12 mm · Supplied without mounting hardware

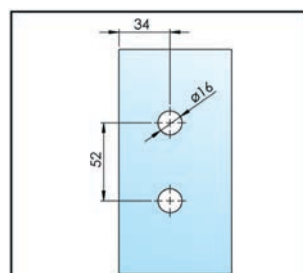
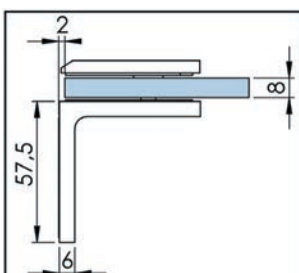
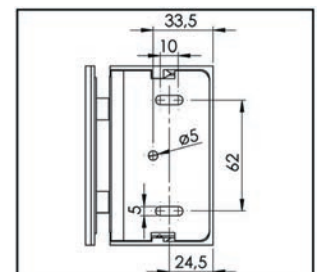
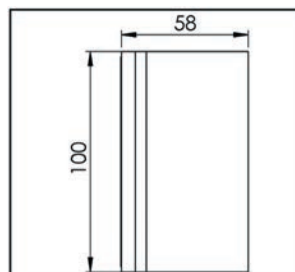

Corner Clamp Bilbao Premium glass/wall 90°



FINISH	ART. NO.
shiny chrome-plated	B0 5211569N
stainless steel look	B0 5211570N
max. door weight per pair	- kg
max. door height	- mm
max. door width	- mm
material	brass

i Glass thickness 8, 10, 12 mm · Supplied without mounting hardware

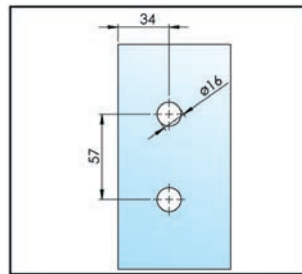
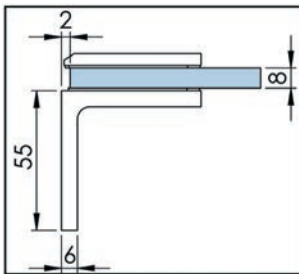
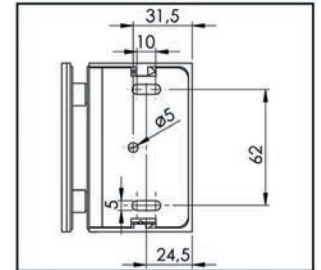
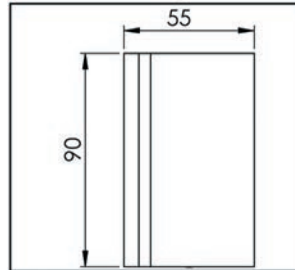

Bohle Bilbao Select Shower Door Hinges

The Bilbao Select shower door hinge series combines modern, square design with useful technical details. Thanks to its versatility and functionality as well as its outstanding price/performance ratio, the Bilbao Select range is popular with builders, planners and architects. Bilbao Select is equipped with a self-closing function starting from an opening angle of approx. $\pm 15^\circ$. Outside this range, the hinge can stop in any position. In addition, the Bilbao Select series benefits from an adjustable zero position, making the alignment of the door much easier for installers.



Shower Door Hinge Bilbao Select glass / wall 90°, one side wall mounted



i Glass thickness 8, 10, 12 mm · Self-closing from 15° · Continuously adjustable zero position · Supplied without mounting hardware

FINISH	ART. NO.
shiny chrome-plated	BO 5211546
stainless steel look	BO 5211547
max. door weight per pair	40 kg
max. door height	2000 mm
max. door width	1000 mm
material	brass

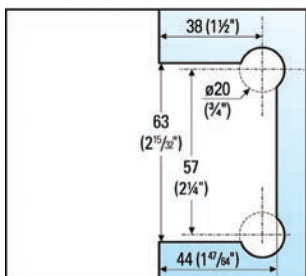
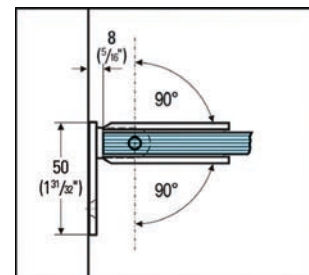
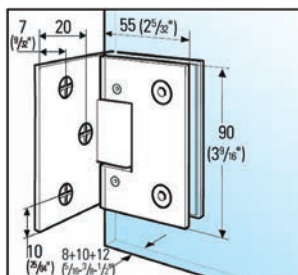

Shower Door Hinge Bilbao Select glass / wall 90°, both sides wall mounted



i Glass thickness 8, 10, 12 mm · Self-closing from 15° · Continuously adjustable zero position · Supplied without mounting hardware

FINISH	ART. NO.
shiny chrome-plated	BO 5211516
stainless steel look	BO 5211517
max. door weight per pair	40 kg
max. door height	2000 mm
max. door width	1000 mm
material	brass

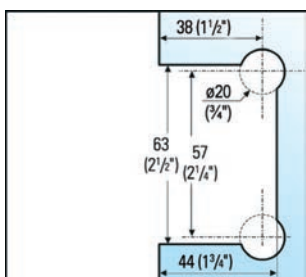
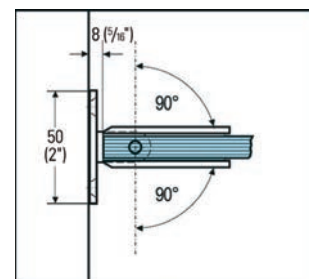
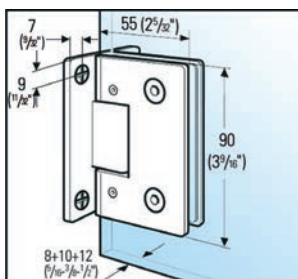

Shower Door Hinge Bilbao Select glass/glass 90°



FINISH	ART. NO.
shiny chrome-plated	B0 5211806
max. door weight per pair	40 kg
max. door height	2000 mm
max. door width	1000 mm
material	brass

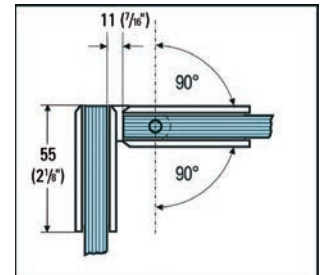
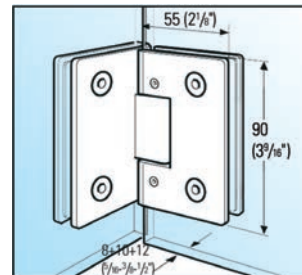

i Glass thickness 8, 10, 12 mm · Self-closing from 15° · Continuously adjustable zero position · For mounting doors to a fixed sidelight

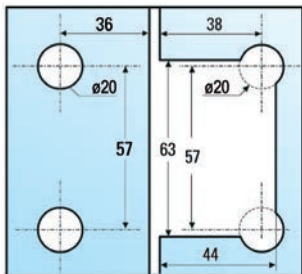

Shower Door Hinge Bilbao Select glass/glass 135°



FINISH	ART. NO.
shiny chrome-plated	B0 5211906
max. door weight per pair	40 kg
max. door height	2000 mm
max. door width	1000 mm
material	brass

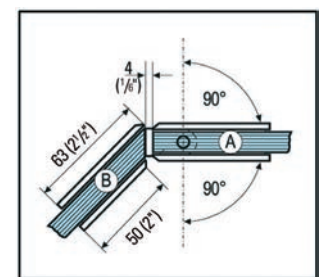
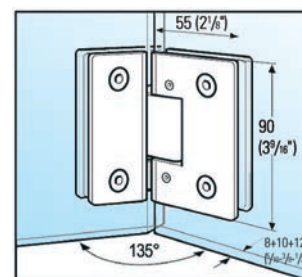

i Glass thickness 8, 10, 12 mm · Self-closing from 15° · Continuously adjustable zero position · For mounting doors to a fixed sidelight

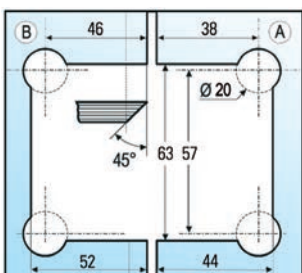

Shower Door Hinge Bilbao Select glass/glass 180°

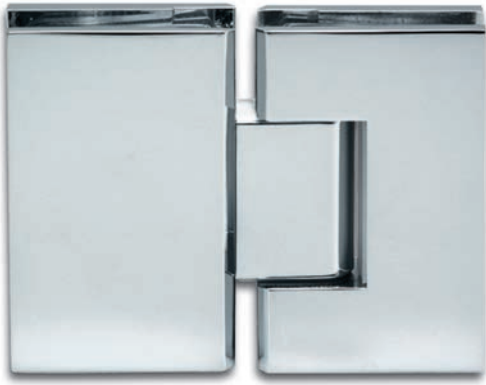

i Glass thickness 8, 10, 12 mm · Self-closing from 15° · Continuously adjustable zero position · For mounting doors to a fixed sidelight

FINISH	ART. NO.
shiny chrome-plated	BO 5211716
stainless steel look	BO 5211717
max. door weight per pair	40 kg
max. door height	2000 mm
max. door width	1000 mm
material	brass

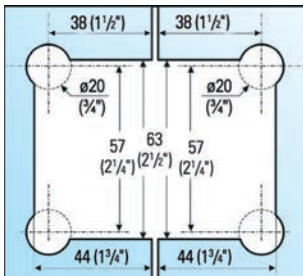
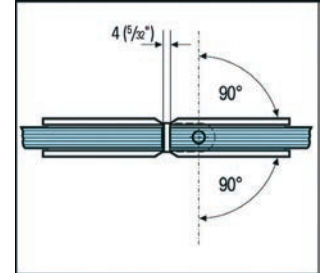
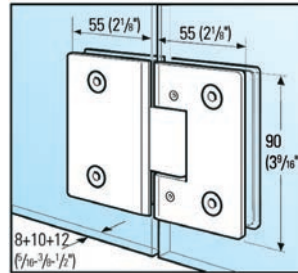

Connector Bilbao glass/wall 90°



i Glass thickness 8, 10, 12 mm · Supplied without mounting hardware · For fixed partitions

FINISH	ART. NO.
shiny chrome-plated	BO 5218420
stainless steel look	BO 5218421
max. door weight per pair	– kg
max. door height	– mm
max. door width	– mm
material	brass

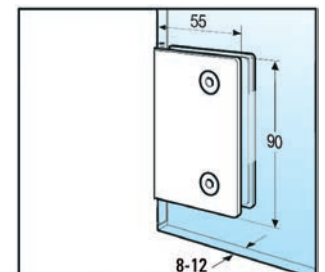
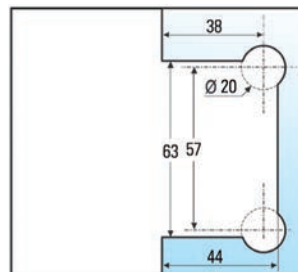

Corner Clamp Bilbao glass/wall 90°



FINISH	ART. NO.
shiny chrome-plated	B0 5213142
stainless steel look	B0 5213143
max. door weight per pair	– kg
max. door height	– mm
max. door width	– mm
material	brass

① Glass thickness 8, 10, 12 mm · Supplied without mounting hardware · For fixed partitions

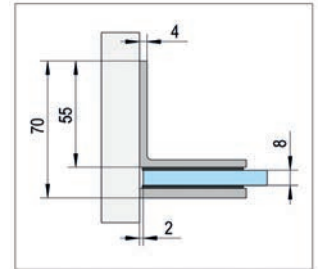
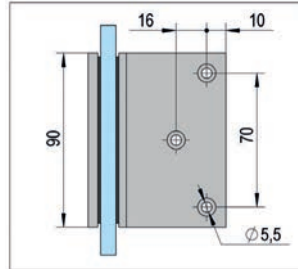
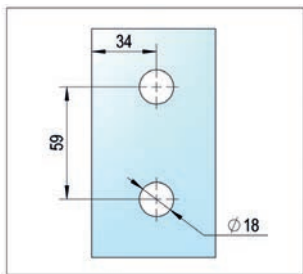

Corner Clamp Bilbao glass/glass 90°



FINISH	ART. NO.
shiny chrome-plated	B0 5213152
stainless steel look	B0 5213153
max. door weight per pair	– kg
max. door height	– mm
max. door width	– mm
material	brass

① Glass thickness 8, 10, 12 mm · For fixed partitions

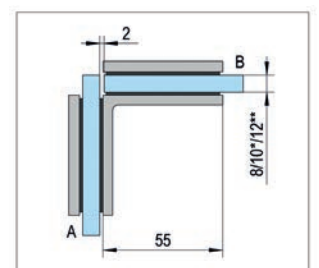
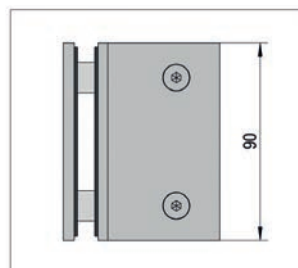
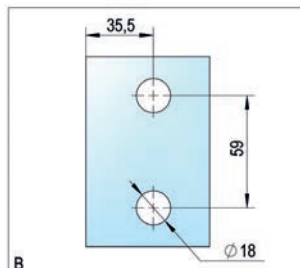
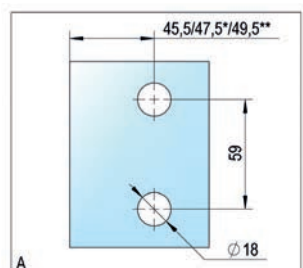

Side Connector Bilbao glass/glass 180°



FINISH	ART. NO.
shiny chrome-plated	B0 5213162
stainless steel look	B0 5213163
max. door weight per pair	– kg
max. door height	– mm
max. door width	– mm
material	brass

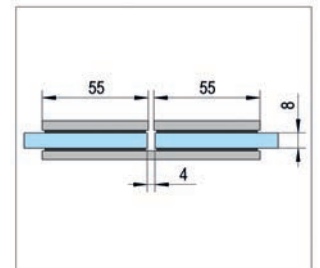
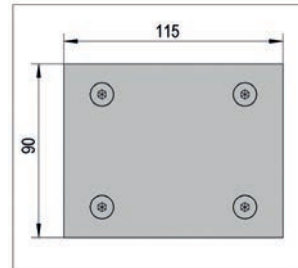

i Glass thickness 8, 10, 12 mm · For fixed partitions

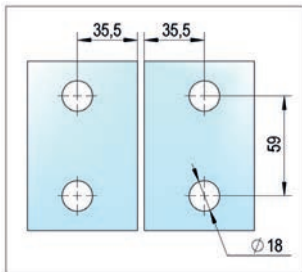

The Bilbao Select, Aqua and Milano Original shower door hinges are available in a black finish. We also offer suitable reinforcement bars and handles.



Bohle Bilbao Shower Door Hinges

The Bilbao shower door hinge series combines modern, square design with useful technical details. Thanks to its versatility and functionality as well as its outstanding price/performance ratio, the Bilbao range is popular with builders, planners and architects. Bilbao is equipped with a self-closing function starting from an opening angle of approx. +/-15°. Outside this range, the hinge can stop in any position.

Shower Door Hinge Bilbao glass/wall 90°, one side wall mounted



❶ Glass thickness 8, 10, 12 mm · Self-closing from 15° · Supplied without mounting hardware

FINISH	ART. NO.
shiny chrome-plated	BO 5211549
stainless steel look	BO 5211550
max. door weight per pair	36 kg
max. door height	2000 mm
max. door width	900 mm
material	brass

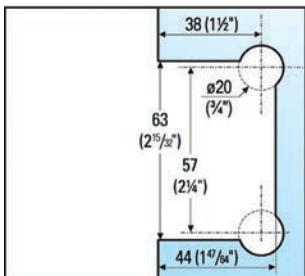
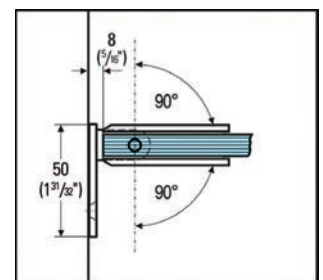
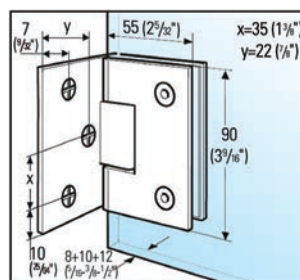

Shower Door Hinge Bilbao glass/glass 180°

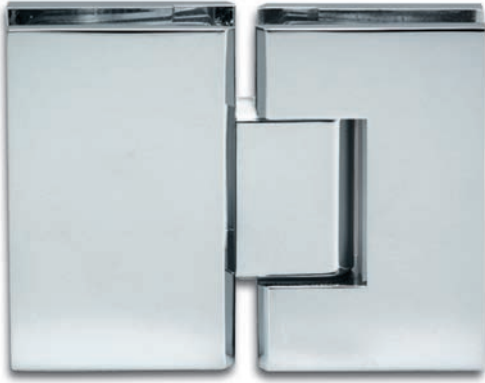

i Glass thickness 8, 10, 12 mm · Self-closing from 15° · For mounting doors to a fixed sidelight

FINISH	ART. NO.
shiny chrome-plated	BO 5218210
stainless steel look	BO 5218211
max. door weight per pair	36 kg
max. door height	2000 mm
max. door width	900 mm
material	brass

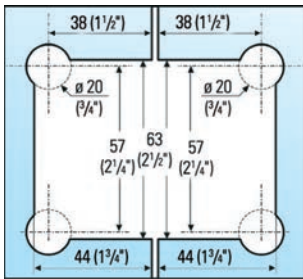
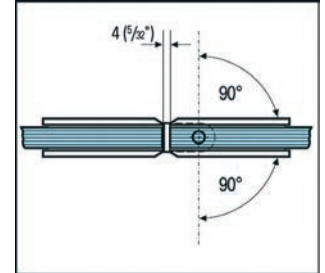
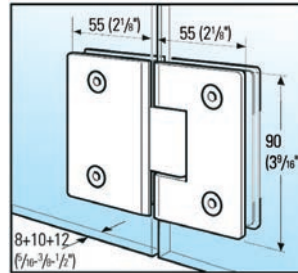

Connector Bilbao glass/wall 90°



i Glass thickness 8, 10, 12 mm · Supplied without mounting hardware · For fixed partitions

FINISH	ART. NO.
shiny chrome-plated	BO 5218420
stainless steel look	BO 5218421
max. door weight per pair	– kg
max. door height	– mm
max. door width	– mm
material	brass

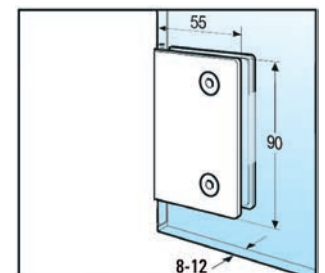
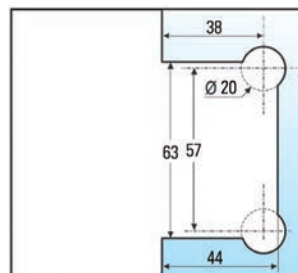

Corner Clamp Bilbao glass/wall 90°



① Glass thickness 8, 10, 12 mm · Supplied without mounting hardware · For fixed partitions

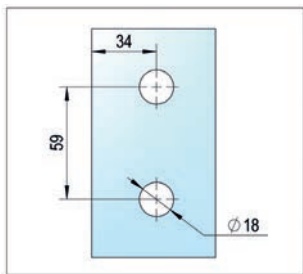

FINISH	ART. NO.
shiny chrome-plated	B0 5213142
stainless steel look	B0 5213143
max. door weight per pair	– kg
max. door height	– mm
max. door width	– mm
material	brass

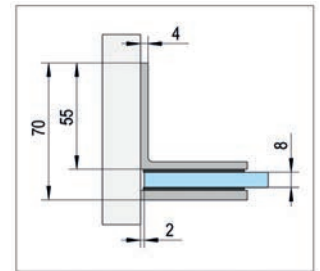
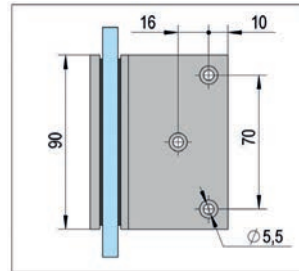

Corner Clamp Bilbao glass/glass 90°



① Glass thickness 8, 10, 12 mm · For fixed partitions

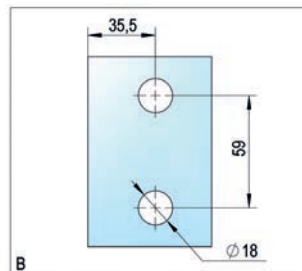
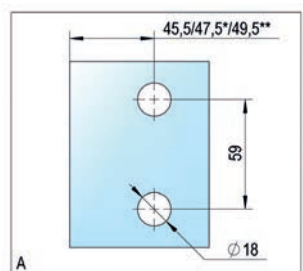

FINISH	ART. NO.
shiny chrome-plated	B0 5213152
stainless steel look	B0 5213153
max. door weight per pair	– kg
max. door height	– mm
max. door width	– mm
material	brass

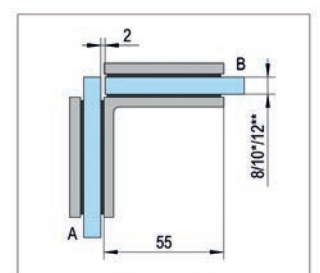
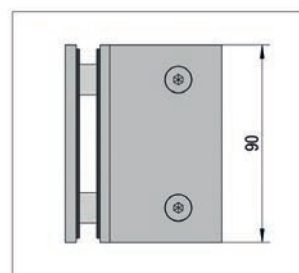

Side Connector Bilbao glass/glass 180°



i Glass thickness 8, 10, 12 mm · For fixed partitions

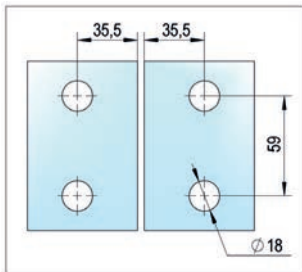

FINISH	ART. NO.
shiny chrome-plated	B0 5213162
stainless steel look	B0 5213163
max. door weight per pair	– kg
max. door height	– mm
max. door width	– mm
material	brass

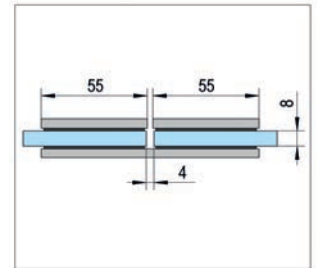
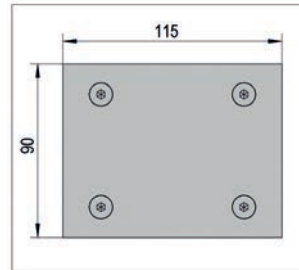

Bohle Barcelona Select Shower Door Hinges

Barcelona Select makes the perfect shower door hinge for the comfortable family bathroom. The harmonious design with rounded-off edges is versatile in use. Barcelona Select is also extremely sturdy and highly functional. Barcelona Select is equipped with a self-closing function starting from an opening angle of approx. $\pm 15^\circ$. Outside this range, the hinge can stop in any position. Unlike Barcelona Basic, Barcelona Select offers an adjustable zero position, making the alignment of the door much easier for installers.



Shower Door Hinge Barcelona Select glass / wall 90°, one side wall mounted



FINISH	ART. NO.
shiny chrome-plated	BO 5219110
stainless steel look	BO 5219111
max. door weight per pair	40 kg
max. door height	2000 mm
max. door width	1000 mm
material	brass

i Glass thickness 8, 10, 12 mm · Self-closing from 15° · Continuously adjustable zero position · Supplied without mounting hardware

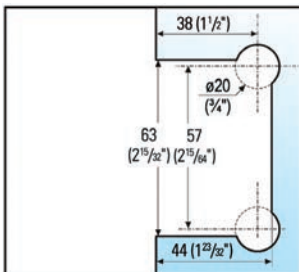
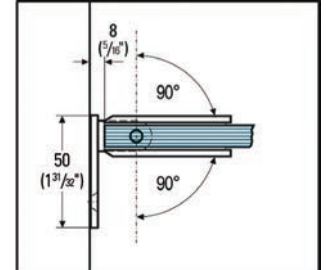
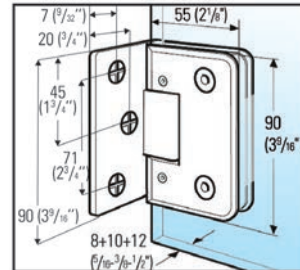

Shower Door Hinge Barcelona Select glass/wall 90°, both sides wall mounted



FINISH	ART. NO.
shiny chrome-plated	BO 5219114
stainless steel look	BO 5219115
max. door weight per pair	40 kg
max. door height	2000 mm
max. door width	1000 mm
material	brass

i Glass thickness 8, 10, 12 mm · Self-closing from 15° · Continuously adjustable zero position · Supplied without mounting hardware

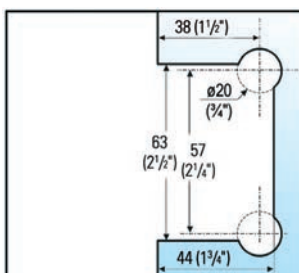
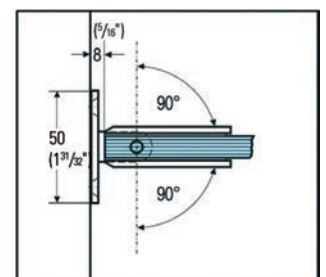
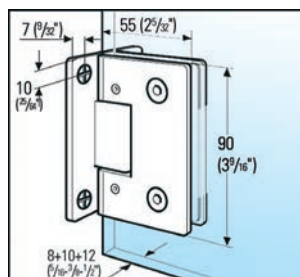

Shower Door Hinge Barcelona Select glass/wall 90°, divided mounting plate



i Glass thickness 8, 10, 12 mm · Self-closing from 15° · Continuously adjustable zero position · Supplied without mounting hardware

FINISH	ART. NO.
shiny chrome-plated	BO 5219130
stainless steel look	BO 5219131
max. door weight per pair	40 kg
max. door height	2000 mm
max. door width	1000 mm
material	brass

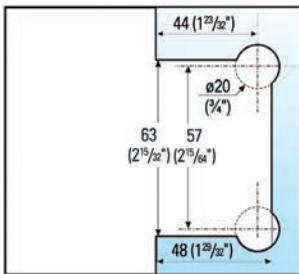
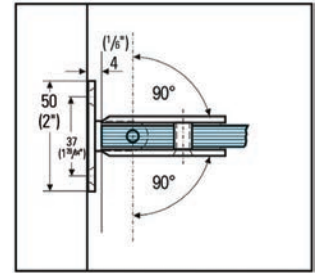
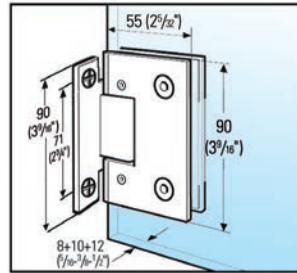

Shower Door Hinge Barcelona Select glass/glass 180°



i Glass thickness 8, 10, 12 mm · Self-closing from 15° · Continuously adjustable zero position · For mounting doors to a fixed sidelight

FINISH	ART. NO.
shiny chrome-plated	BO 5219118
stainless steel look	BO 5219119
max. door weight per pair	40 kg
max. door height	2000 mm
max. door width	1000 mm
material	brass

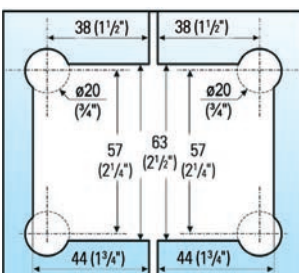
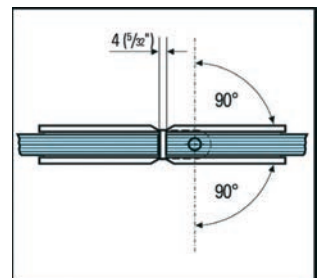
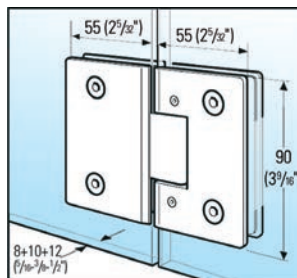

Shower Door Hinge Barcelona Select glass/glass 135°



i Glass thickness 8, 10, 12 mm · Self-closing from 15° · Continuously adjustable zero position · For mounting doors to a fixed sidelight

FINISH	ART. NO.
shiny chrome-plated	B0 5219122
max. door weight per pair	40 kg
max. door height	2000 mm
max. door width	1000 mm
material	brass

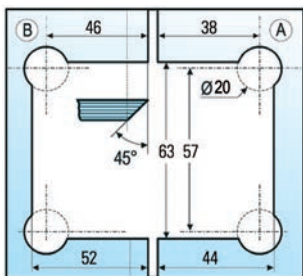
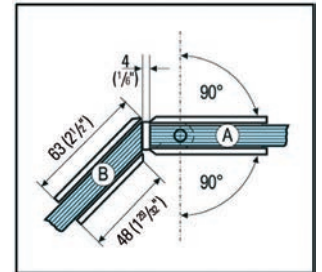
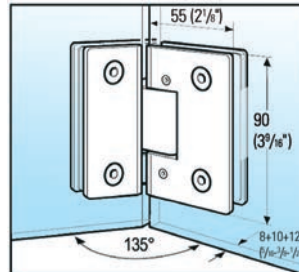

Shower Door Hinge Barcelona Select glass/glass 90°



i Glass thickness 8, 10, 12 mm · Self-closing from 15° · Continuously adjustable zero position · For mounting doors to a fixed sidelight

FINISH	ART. NO.
shiny chrome-plated	B0 5219126
max. door weight per pair	40 kg
max. door height	2000 mm
max. door width	1000 mm
material	brass

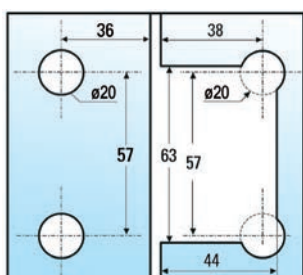
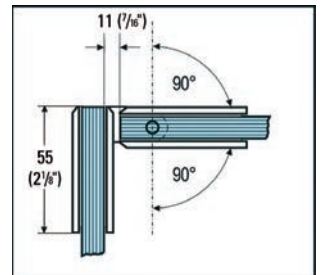
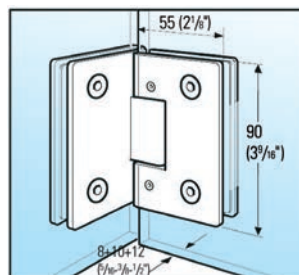

Connector Barcelona glass/wall 90°



i Glass thickness 8, 10, 12 mm · Supplied without mounting hardware · For fixed partitions

FINISH	ART. NO.
shiny chrome-plated	BO 5219050
stainless steel look	BO 5219051
max. door weight per pair	– kg
max. door height	– mm
max. door width	– mm
material	brass

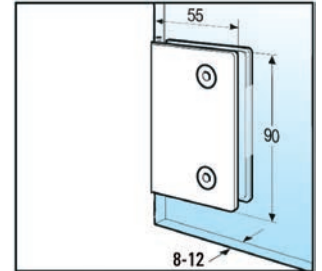
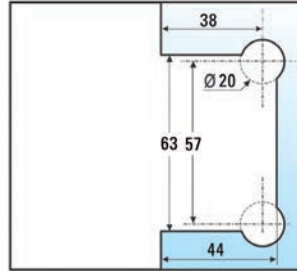

Corner Clamp Barcelona glass/glass 90°



i Glass thickness 8, 10, 12 mm · For fixed partitions · x = glass thickness

FINISH	ART. NO.
shiny chrome-plated	BO 5219060
stainless steel look	BO 5219061
max. door weight per pair	– kg
max. door height	– mm
max. door width	– mm
material	brass

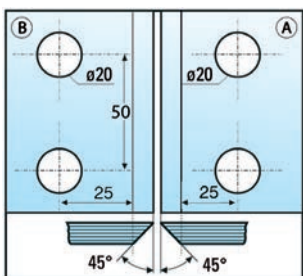
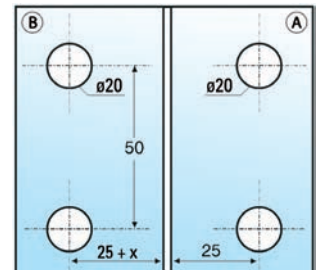
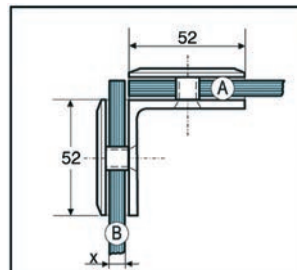

Corner Clamp Barcelona glass/wall 90°



FINISH	ART. NO.
shiny chrome-plated	B0 5219080
stainless steel look	B0 5219081
max. door weight per pair	- kg
max. door height	- mm
max. door width	- mm
material	brass

i Glass thickness 8, 10, 12 mm · Supplied without mounting hardware · For fixed partitions

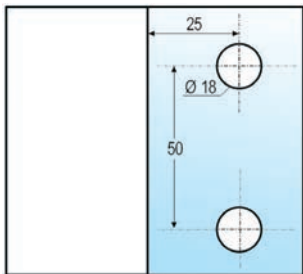
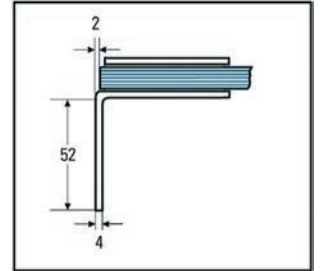
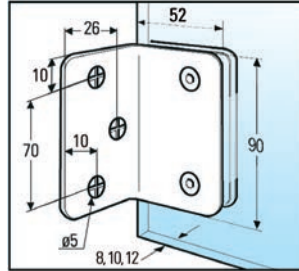

Bohle Barcelona Shower Door Hinges

Barcelona makes the perfect shower door hinge for the comfortable family bathroom. The harmonious design with rounded-off edges is versatile in use. Barcelona is also extremely sturdy and highly functional. Barcelona is equipped with a self-closing function starting from an opening angle of approx. +/-15°. Outside this range, the hinge can stop in any position.

Shower Door Hinge Barcelona glass/wall 90°, one side wall mounted



i Glass thickness 8, 10, 12 mm · Self-closing from 15° · Supplied without mounting hardware

FINISH	ART. NO.
shiny chrome-plated	B0 5218110
stainless steel look	B0 5218111
max. door weight per pair	36 kg
max. door height	2000 mm
max. door width	900 mm
material	brass

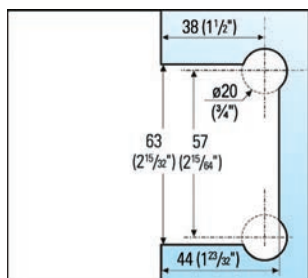
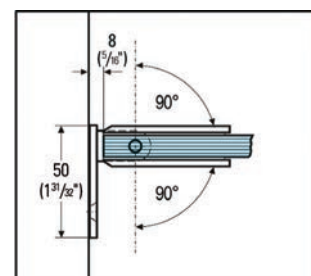
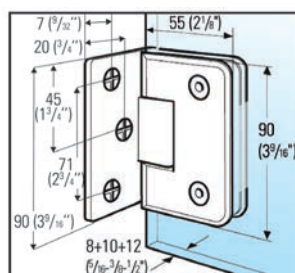

Shower Door Hinge Barcelona glass/wall 90°, both sides wall mounted



FINISH	ART. NO.
shiny chrome-plated	BO 5219010
stainless steel look	BO 5219011
max. door weight per pair	36 kg
max. door height	2000 mm
max. door width	900 mm
material	brass

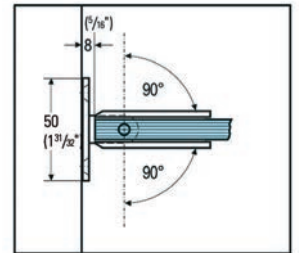
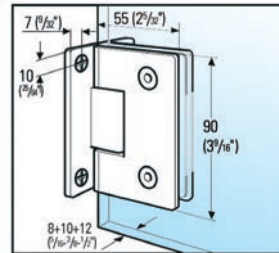

i Glass thickness 8, 10, 12 mm · Self-closing from 15° · Supplied without mounting hardware

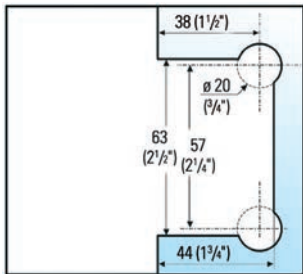

Shower Door Hinge Barcelona glass/glass 180°



FINISH	ART. NO.
shiny chrome-plated	BO 5219210
stainless steel look	BO 5219211
max. door weight per pair	36 kg
max. door height	2000 mm
max. door width	900 mm
material	brass

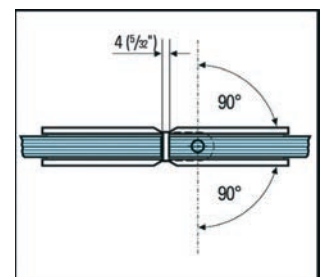
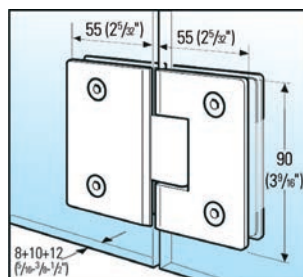

i For mounting doors to a fixed sidelight · Glass thickness 8, 10, 12 mm · Self-closing from 15°

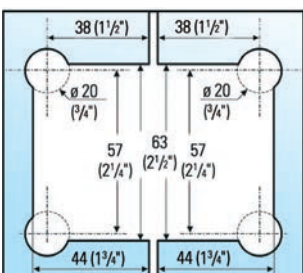

Connector Barcelona glass/wall 90°



i Glass thickness 8, 10, 12 mm · Supplied without mounting hardware · For fixed partitions

FINISH	ART. NO.
shiny chrome-plated	BO 5219050
stainless steel look	BO 5219051
max. door weight per pair	– kg
max. door height	– mm
max. door width	– mm
material	brass

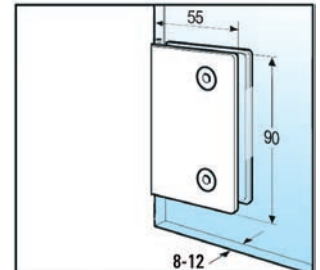
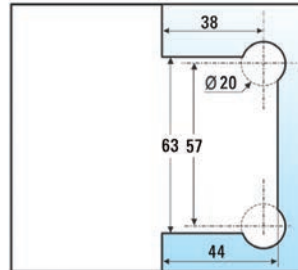

Corner Clamp Barcelona glass/glass 90°



i Glass thickness 8, 10, 12 mm · For fixed partitions · x = glass thickness

FINISH	ART. NO.
shiny chrome-plated	BO 5219060
stainless steel look	BO 5219061
max. door weight per pair	– kg
max. door height	– mm
max. door width	– mm
material	brass

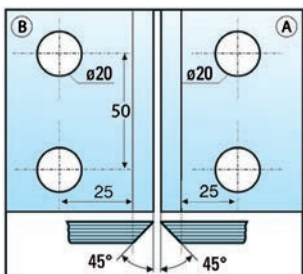
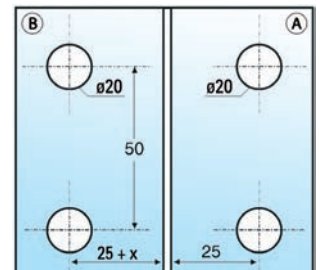
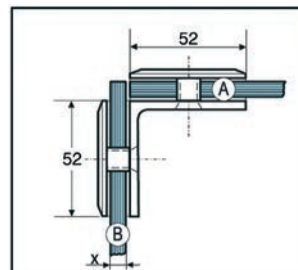

Corner Clamp Barcelona glass/wall 90°



FINISH	ART. NO.
shiny chrome-plated	BO 5219080
stainless steel look	BO 5219081
max. door weight per pair	– kg
max. door height	– mm
max. door width	– mm
material	brass

i Glass thickness 8, 10, 12 mm · Supplied without mounting hardware · For fixed partitions

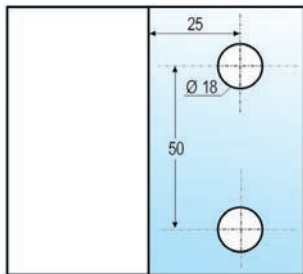
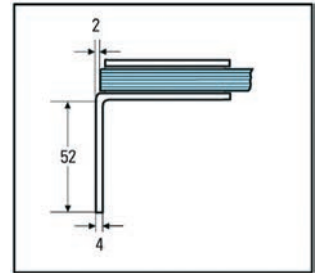
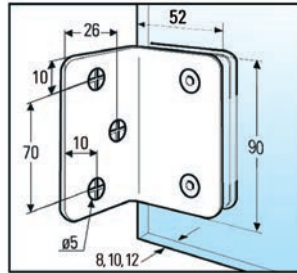

Corner Clamp Milano Original / Milano Premium glass/wall 90°



i Glass thickness 8, 10 mm

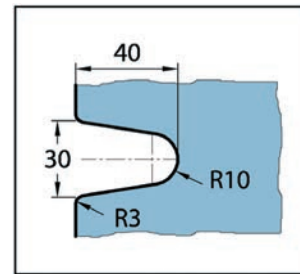
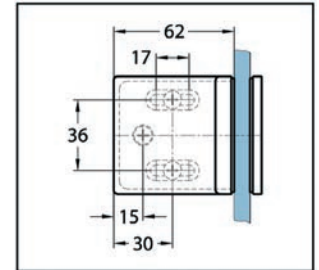
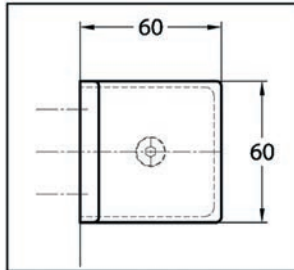
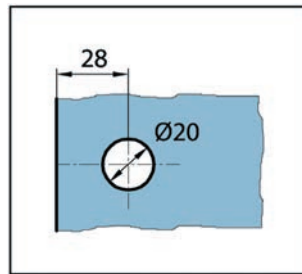
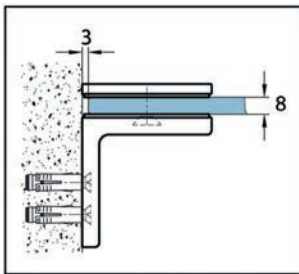

Corner Clamp Milano Original / Milano Premium glass/glass 90°



i Glass thickness 8, 10 mm

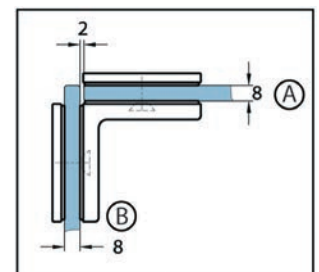
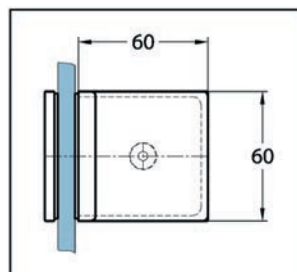
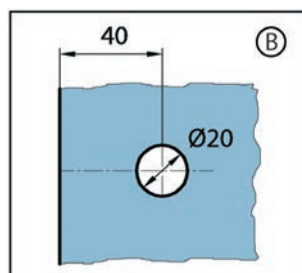
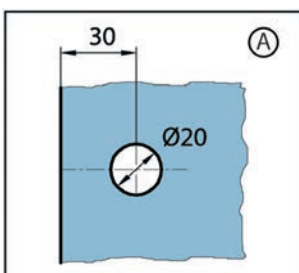

FINISH	ART. NO.
shiny chrome-plated	BK 0749331
stainless steel look	BK 0749355
max. door weight per pair	– kg
max. door height	– mm
max. door width	– mm
material	brass

FINISH	ART. NO.
shiny chrome-plated	BK 0749331
stainless steel look	BK 0749355
max. door weight per pair	– kg
max. door height	– mm
max. door width	– mm
material	brass

Side Connector Milano Original / Milano Premium glass/glass 180°



i Glass thickness 8, 10 mm

FINISH	ART. NO.
shiny chrome-plated	BK 0749931
stainless steel look	BK 0749955
max. door weight per pair	– kg
max. door height	– mm
max. door width	– mm
material	brass

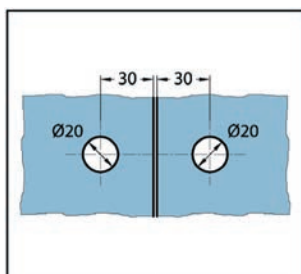
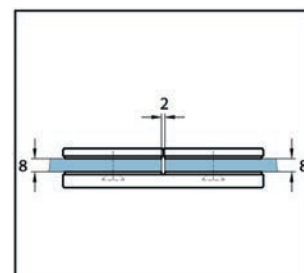
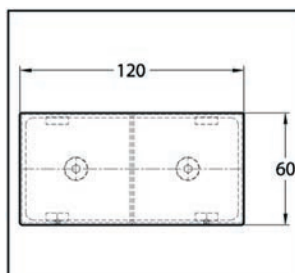

The Bilbao Select, Aqua and Milano Original shower door hinges are available in a black finish. We also offer suitable reinforcement bars and handles.



Aqua Shower Door Hinges

Bohle Aqua shower door fittings are the perfect alternative to all conventional shower door hinges. The full length aluminium profile system combines a simple and elegant design with all the technical standards of today: an infinitely adjustable zero position, a raising/lowering mechanism as well as a ± 6 mm vertical shim. In addition, the glass is bonded with silicone so no glass processing is required.



Shower Door Hinge Aqua glass/wall 90° for 6 mm



i Glass thickness 6 mm · Lifting height 5 mm · Hold position both sides at 90° · Profile length 2200 mm · Can be cut to the desired length · Please order two sets for double door applications. · Special profiles are also available as accessories for connecting to sidelights. · The deduction dimension of 13 mm has already been taken into account in the glass deduction for inserting the water deflector BO 5213494. If another water deflector is used, the deduction must be adapted accordingly.

INCLUDED IN DELIVERY:

1x	Wall profile
1x	Intermediate profile with brush strips
1x	Glass profile
1x	Accessory set incl. end stops

FINISH	ART. NO.
aluminium-coloured anodised E6/EV1	BO 5200405
polished anodised E3/EV1	BO 5200406
max. door weight per pair	35 kg
max. door height	2187 mm
max. door width	800 mm
material	aluminium

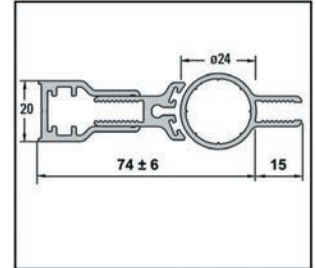
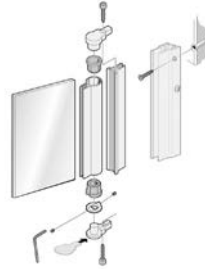

Shower Door Hinge Aqua glass/wall 90° for 8 mm



i Glass thickness 8 mm · Lifting height 5 mm · Hold position both sides at 90° · Profile length 2200 mm · Can be cut to the desired length · Please order two sets for double door applications. · Special profiles are also available as accessories for connecting to sidelights. · The deduction dimension of 13 mm has already been taken into account in the glass deduction for inserting the water deflector BO 5213494. If another water deflector is used, the deduction must be adapted accordingly.

INCLUDED IN DELIVERY:

1x	Wall profile
1x	Intermediate profile with brush strips
1x	Glass profile
1x	Accessory set incl. end stops

FINISH	ART. NO.
aluminium-coloured anodised E6/EV1	BO 5200407
polished anodised E3/EV1	BO 5200408
max. door weight per pair	35 kg
max. door height	2187 mm
max. door width	800 mm
material	aluminium

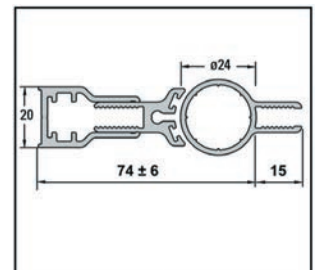
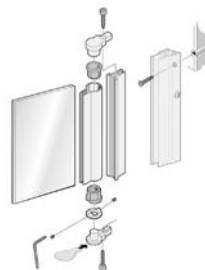

Aqua Adapter Profile for fixed sidelight for 6 mm



i Glass thickness 6 mm · Profile length 2200 mm · Can be cut to the desired length · Profiles for glass-floor connection of the sidelight are not included and must be ordered separately.

FINISH	ART. NO.
aluminium-coloured anodised E6/EV1	BO 5200409
polished anodised E3/EV1	BO 5200410
max. door weight per pair	– kg
max. door height	– mm
max. door width	– mm
material	aluminium

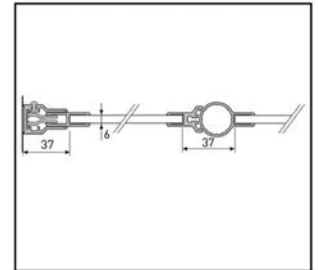
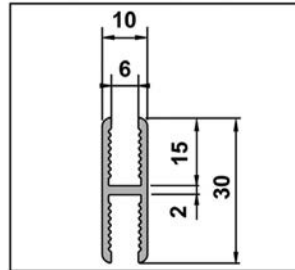

Aqua Adapter Profile for fixed sidelight for 8 mm



i Glass thickness 8 mm · Profile length 2200 mm · Can be cut to the desired length · Profiles for glass-floor connection of the sidelight are not included and must be ordered separately.

FINISH	ART. NO.
aluminium-coloured anodised E6/EV1	BO 5200416
polished anodised E3/EV1	BO 5200417
max. door weight per pair	– kg
max. door height	– mm
max. door width	– mm
material	aluminium

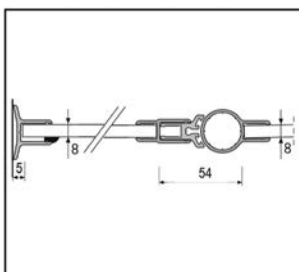
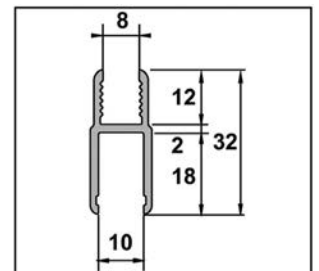
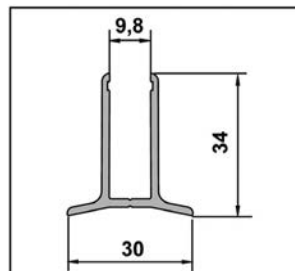

INCLUDED IN DELIVERY:

1x
1x
1x
1x

8 mm wall connection profile
Rubber profile
8 mm adapter profile
Installation kit

Sliding Door Systems For Showers

	Premium Slide SH	Aquant 40
		
Page	101	105
Recess application single door (max. mm)	1500	1550
Recess application double doors (max. mm)		2050
Corner application single door (max. mm)	1500 x 1100	1150 x 1150
Corner application double doors (max. mm)	1000 x 1000	1150 x 1150
Glass thickness tempered glass (mm)	8 / 10	8
max. door weight (kg)	60	40

Bohle Premium Slide SH Sliding Shower Door System

The Premium Slide SH sliding door system for all-glass showers stands out due to its unobtrusive elegance and supreme quality stainless steel. Whether in the private or commercial sector, the Premium Slide SH sliding door system lives up to demands for the highest quality. Bohle offers the following systems as a standard: double door corner application, single door corner application with sidelight, single door recess application.



Premium Slide SH Set, recess application, single door



FINISH	ART. NO.
brushed	BO 5214891
max. door weight	60 kg
max. door height	2200 mm
max. door width	775 mm
material	stainless steel

INCLUDED IN DELIVERY:

1x	Top track
2x	Sliding track holder
2x	Fixed sidelight point fixing
2x	Door point fixing
2x	Stoppers
1x	Bottom guide
2x	Aluminium U-profile
1x	Cover profile

i Glass thickness 8, 10 mm · With threshold · The U-profiles included in the delivery are made of aluminium.

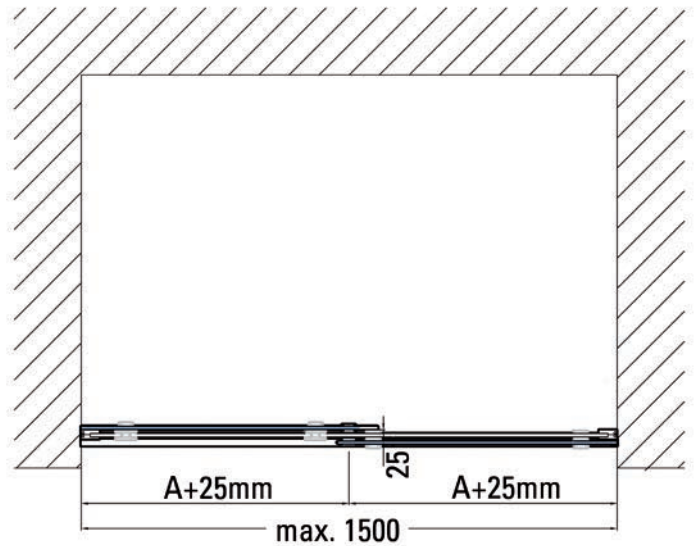
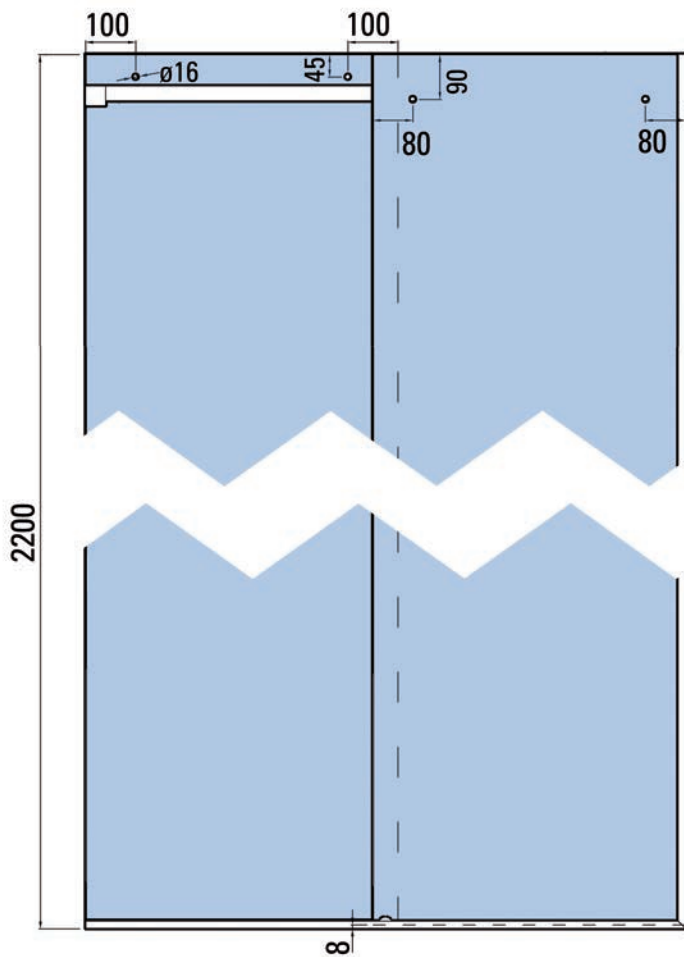

Premium Slide SH Set, corner application, single door, with sidelight



FINISH	ART. NO.
brushed	B0 5214892
max. door weight	60 kg
max. door height	2200 mm
max. door width	775 mm
material	stainless steel

INCLUDED IN DELIVERY:

1x	Top track
2x	Sliding track holder
2x	Fixed sidelight point fixing
2x	Door point fixing
2x	Stoppers
1x	Bottom guide
4x	Aluminium U-profile
1x	Cover profile

i Glass thickness 8, 10 mm · With threshold · The U-profiles included in the delivery are made of aluminium.

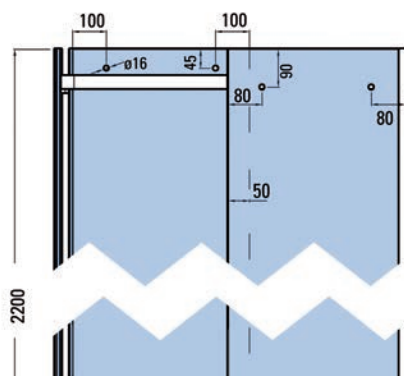
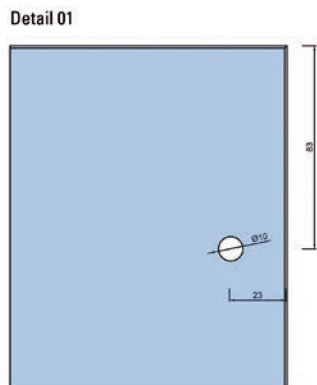
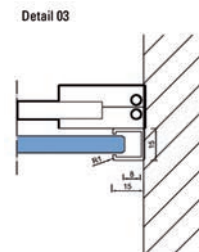
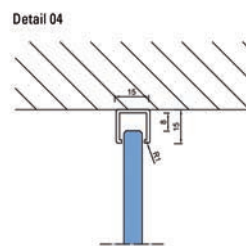
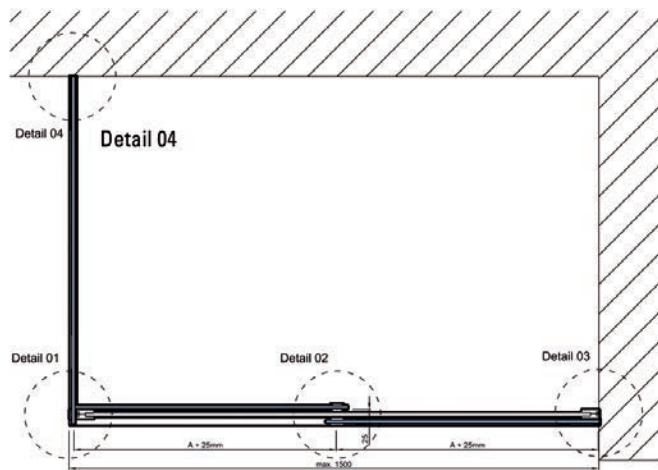
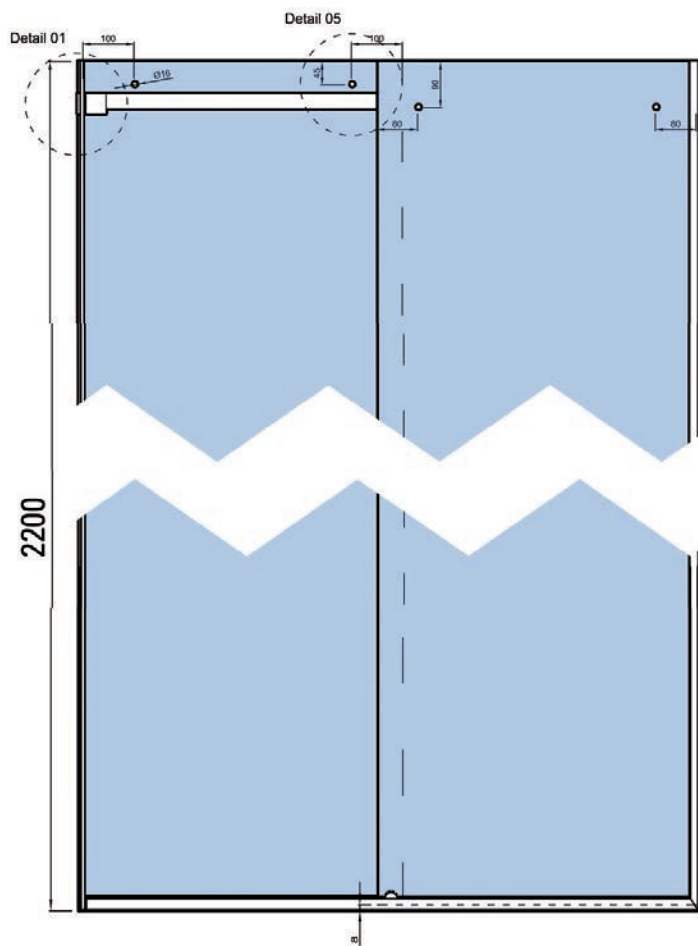

Premium Slide SH Set, corner application, double doors



i Glass thickness 8, 10 mm · With threshold · The U-profiles included in the delivery are made of aluminium.

FINISH	ART. NO.
brushed	B0 5214890

max. door weight	60 kg
max. door height	2200 mm
max. door width	525 mm
material	stainless steel

INCLUDED IN DELIVERY:

2x	Top track
2x	Sliding track holder
4x	Fixed sidelight point fixing
4x	Door point fixing
4x	Stoppers
2x	Bottom guide
4x	Aluminium U-profile
2x	Cover profile
1x	Corner connector for sliding track

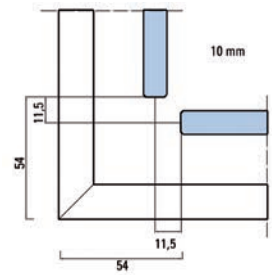
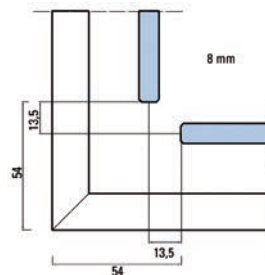
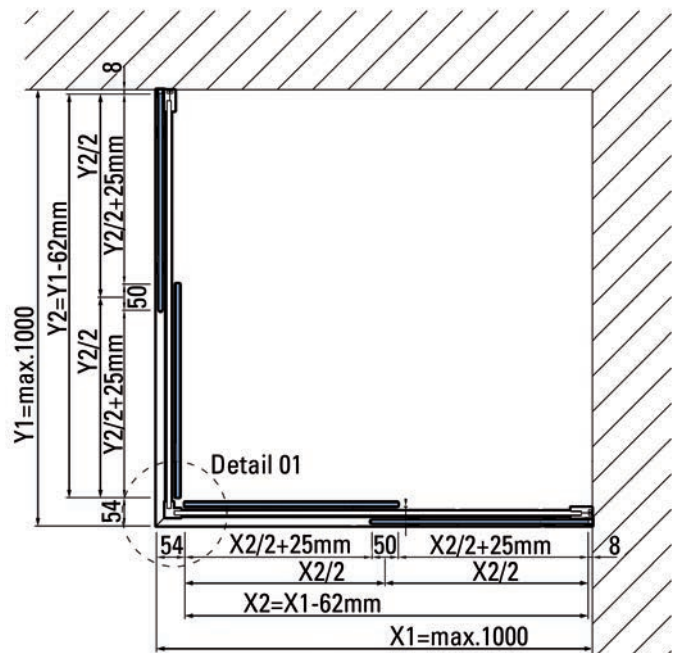
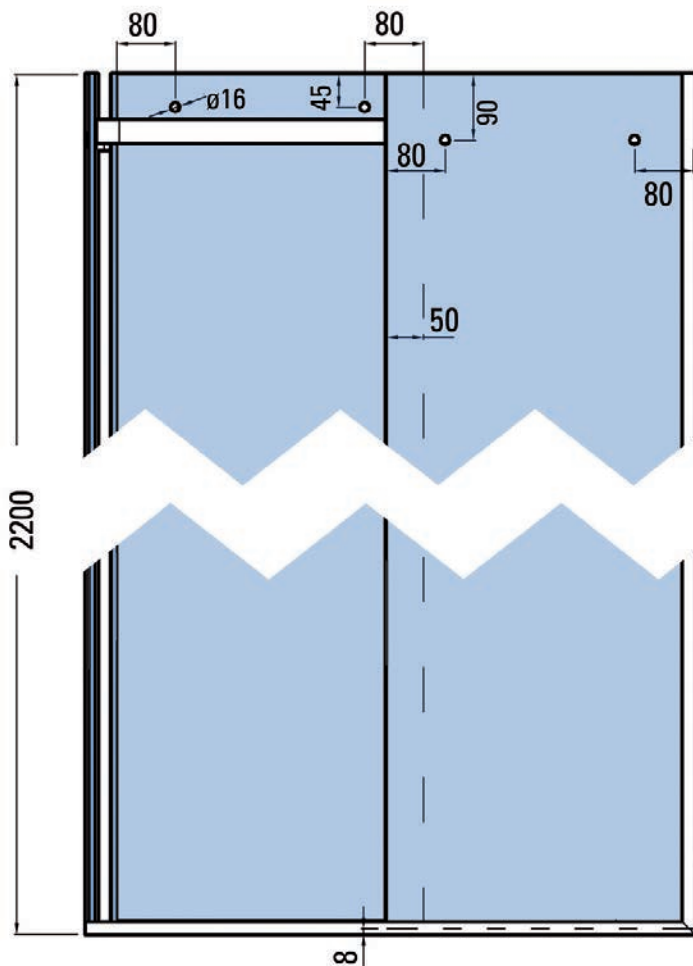

Willach Aquant 40 Sliding Door System

The innovative Aquant 40 glass sliding door fitting is a true miracle in the compact use of space. Despite a cushioning and retraction system on both sides of each sliding sash and completely covered roller assemblies, the slimline profile is only 50 mm high and 57 mm deep. Thanks to sturdy wall brackets and intelligently reinforced profiles, there is no need for ceiling suspension, even with corner and U-showers. As the roller runs above the centre of gravity of the fixed sash, no torque is applied to the track profile; this prevents twisting of the profile. Aquant 40 is suitable for corner, recess or U-showers. It can be used for showers with either one or two sliding sashes. Extension solutions to or on bathtubs are also possible.



Aquant 40 Set, corner application with damping mechanism, single door



MAX. DOOR WEIGHT · LENGTH	ART. NO.
40 kg · 1150 x 1150 mm	BO 5215086
max. door height	2500 mm
max. door width	– mm
material	aluminium
finish	polished

i Glass thickness 8 mm · min. door width 380 mm · Note: Please order bulb seal BO 5215190 or BO 5215191 separately.

INCLUDED IN DELIVERY:

2x	Profile set	Running track, cover, bedding profile for fixed glazing, water deflector
1x	Accessory kit door sash	2x carriages, 2x end stops, 1x damping mechanism for both sides, 2x bottom guides (left, right)
1x	Accessory installation	2x wall holders with screws/dowels, 1x mounting aid set, 1x mounting instructions
1x	Accessory kit corner bracket	1x corner piece, 1x stainless steel cover cap for end piece, 2x holders for end piece

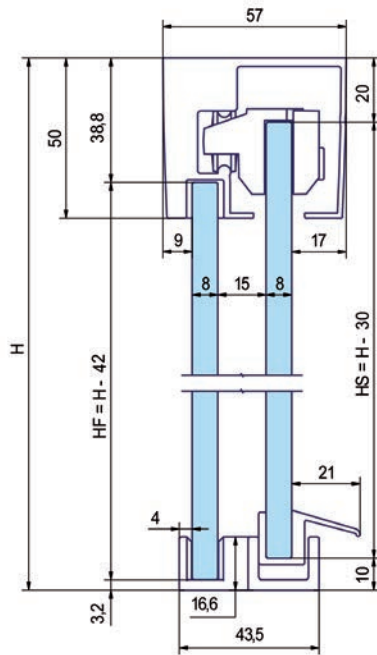

Aquant 40 Set, corner application with damping mechanism, double doors



MAX. DOOR WEIGHT · LENGTH	ART. NO.
20 kg · 950 x 950 mm	BO 5215087
40 kg · 1150 x 1150 mm	BO 5215088
max. door height	2500 mm
max. door width	– mm
material	aluminium
finish	polished

i Glass thickness 8 mm · min. door width 380 mm · Note: Please order bulb seal BO 5215190 or BO 5215191 separately.

INCLUDED IN DELIVERY:

2x	Profile set	Running track, cover, bedding profile for fixed glazing, water deflector
2x	Accessory kit door sash	2x carriages, 2x end stops, 1x damping mechanism for both sides, 2x bottom guides (left, right)
1x	Accessory installation	2x wall holders with screws/dowels, 1x mounting aid set, 1x mounting instructions
1x	Accessory kit corner bracket	1x corner piece, 1x stainless steel cover cap for end piece, 2x holders for end piece

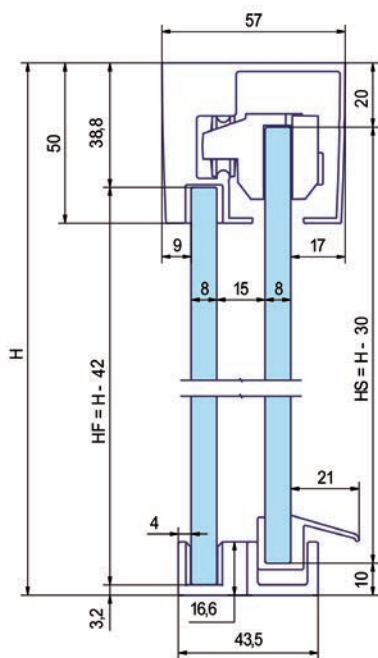

Aquant 40 Set, recess application with damping mechanism, single door



MAX. DOOR WEIGHT · LENGTH	ART. NO.
40 kg · 1150 mm	BO 5215089
40 kg · 1550 mm	BO 5215090
max. door height	2500 mm
max. door width	– mm
material	aluminium
Finish	polished

i Glass thickness 8 mm · min. door width 380 mm · Note: Please order bulb seal BO 5215190 or BO 5215191 separately.

INCLUDED IN DELIVERY:

1x	Profile set	Running track, cover, bedding profile for fixed glazing, water deflector
1x	Accessory kit door sash	Carriage, damping mechanism, bottom guide
1x	Accessory installation	2x wall holders with screws/dowels, 1x mounting aid set, 1x mounting instructions

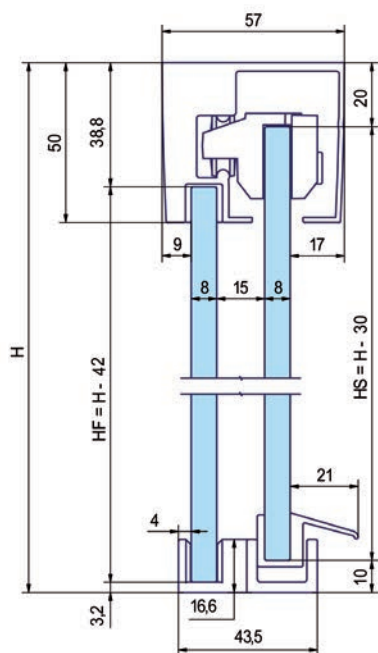

Aquant 40 Set, recess application with damping mechanism, double doors



MAX. DOOR WEIGHT · LENGTH	ART. NO.
20 kg · 2050 mm	BO 5215091
max. door height	2500 mm
max. door width	– mm
material	aluminium
Finish	polished

i Glass thickness 8 mm · min. door width 380 mm · Note: Please order bulb seal BO 5215190 or BO 5215191 separately.

INCLUDED IN DELIVERY:

1x	Profile set	Running track, cover, bedding profile for fixed glazing, water deflector
2x	Accessory kit door sash	Carriage, damping mechanism, bottom guide
1x	Accessory installation	2x wall holders with screws/dowels, 1x mounting aid set, 1x mounting instructions

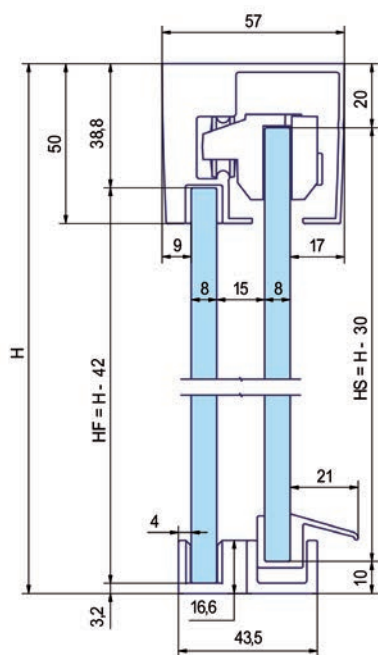

Aquant 40 Profile Set



LENGTH	ART. NO.
950 mm	BO 5215092
1150 mm	BO 5215093
1550 mm	BO 5215094
2050 mm	BO 5215095

Finish	polished
material	aluminium

i Glass thickness 8 mm · min. door width 380 mm · max. widths and heights: for recess showers with one door and a width of up to 1700 mm and with two doors and a width of up to 2000 mm · for corner and U-showers up to 1500 x 1500 mm, corner shower as one-sided application with two doors, also up to 2000 x 1200 mm

INCLUDED IN DELIVERY:

1x	Top track
1x	Cover
1x	Bedding profile for fixed glazing
1x	Water deflector

Aquant 40 Accessory Kit Door Sash

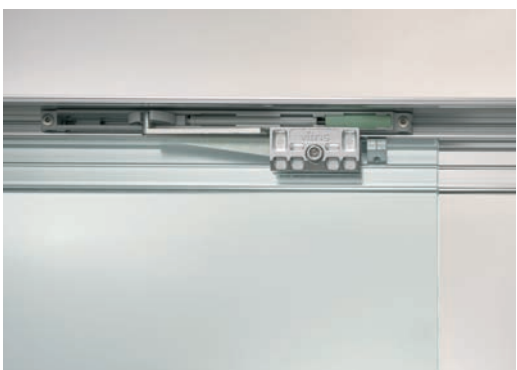

MAX. DOOR WEIGHT	ART. NO.
20 kg	BO 5215096
40 kg	BO 5215097

i Glass thickness 8 mm · min. door width 380 mm

INCLUDED IN DELIVERY:

2x	Carriages
2x	End stops
2x	Damping mechanism for both sides
1x	Bottom guide left
1x	Bottom guide right

Aquant 40 Accessory Installation



ART. NO.

BO 5215098

i Glass thickness 8 mm · min. door width 380 mm · Accessory set for running track installation

INCLUDED IN DELIVERY:

2x	Wall holder with screws/dowels
1x	Mounting aid set
1x	Mounting instructions

Aquant 40 Handle Ø 39 mm



FINISH

ART. NO.

brushed

BO 5215194

Depth

12 mm

material

stainless steel

i Glass thickness 8 mm

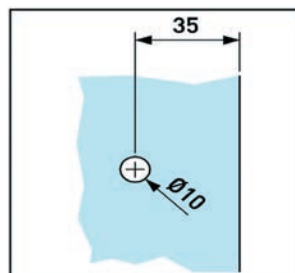

Aquant 40 Accessory Kit Corner Bracket



i Accessory set for connecting running tracks in recess applications

ART. NO.

BO 5215099

INCLUDED IN DELIVERY:

1x	Corner bracket
1x	Stainless steel cover cap for corner piece
2x	Support for corner piece

Aquant 40 bulb seal for recess shower application

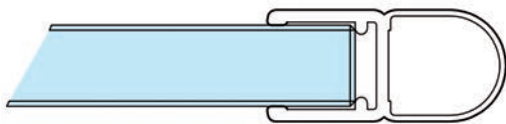

i Glass thickness 8 mm · The glass deduction dimension amounts to 14 mm.

LENGTH

ART. NO.

2000 mm

BO 5215190

2490 mm

BO 5215191

Aquant 40 vertical sealing strips

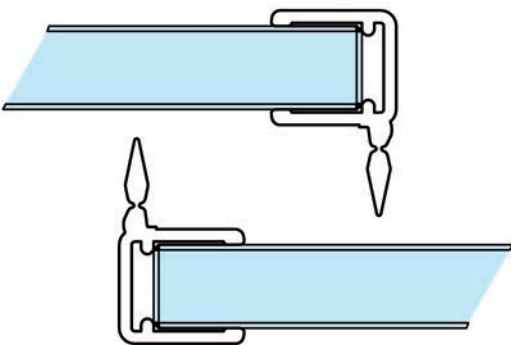

i Glass thickness 8 mm · sealing strips between fixed sidelight and sliding door · Packaging unit 1 pair

LENGTH

ART. NO.

2000 mm

BO 5215192

2490 mm

BO 5215193

Aquant 40 Clamp-on Profile for Wall Connection

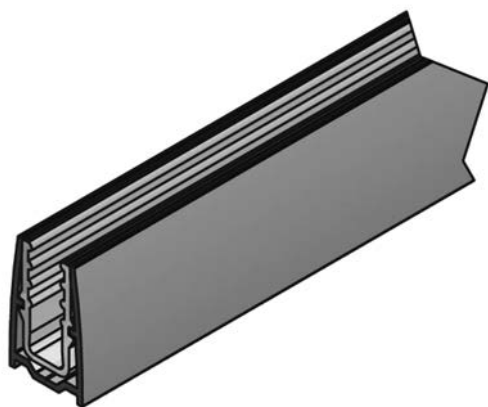

LENGTH	ART. NO.
2000 mm	BO 5215196
2490 mm	BO 5215197
Finish	polished

i Glass thickness 8 mm · Suitable for use with Aquant 40 sliding doors systems · incl. plastic insert, no sealing required

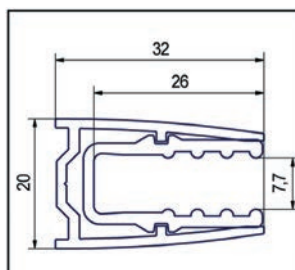

INCLUDED IN DELIVERY:

1x	Clamp-on profile
1x	Clamping insert

Sealing Strip with 90° Magnetic Profile for 6 - 8 mm

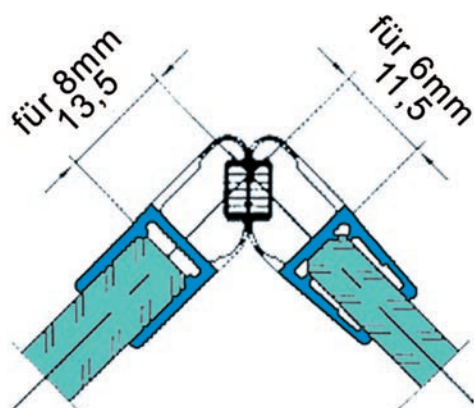

	ART. NO.
	BO 5213529
Length	2160 mm

i Glass thickness 6 - 8 mm · material PVC

Reinforcement Bars

Bohle square

Timelessly modern. With Basic square, Bohle has achieved the perfect mix of form and function. The wide array of models enables almost any kind of customised construction project. Available in mirror polished and matt brushed stainless steel.

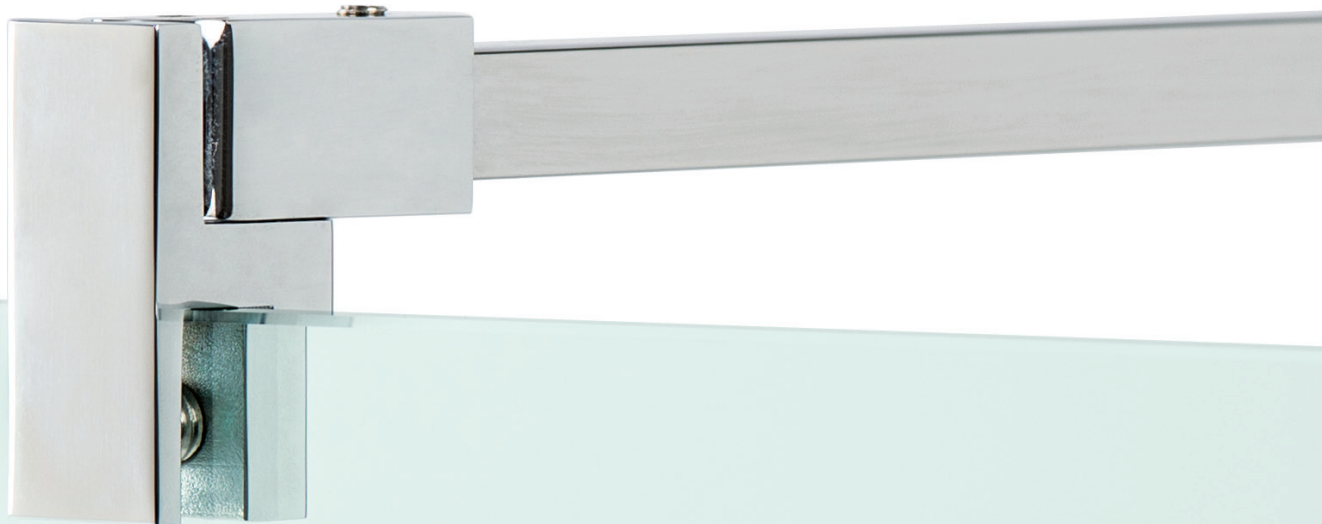

Bohle square 15 x 15 mm

Reinforcement Bar Set Bohle square 15x15 glass/wall 90°



FINISH	ART. NO.
brushed	B0 5420240
polished	B0 5420241
Size	15 x 15 mm
Material	stainless steel
Length	963 mm

i Glass thickness 6, 8, 10 mm

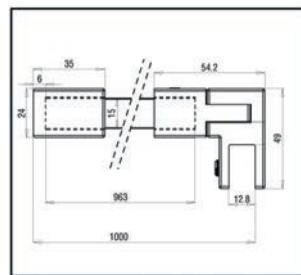
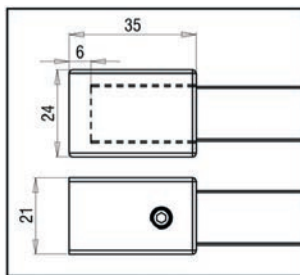
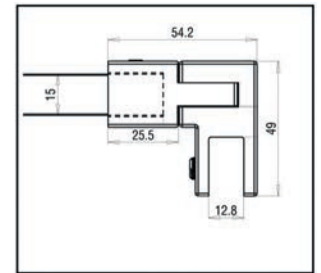
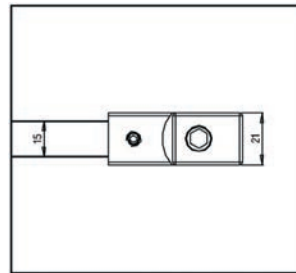

Reinforcement Bar Set Bohle square 15x15 glass/glass



FINISH	ART. NO.
polished	B0 5420237
Size	15 x 15 mm
Material	stainless steel
Length	953 mm

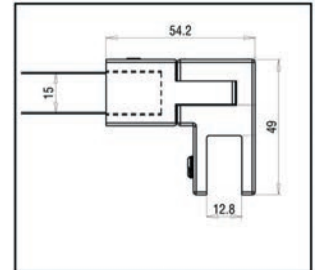
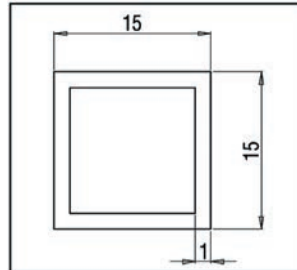

① Glass thickness 6, 8, 10 mm

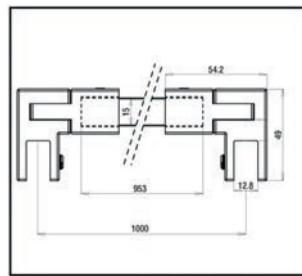
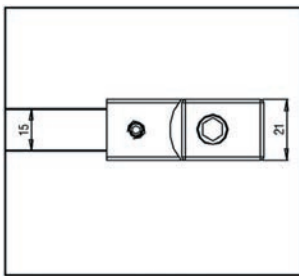

Reinforcement Bar Set Bohle square 15x15 glass/wall 45°



FINISH	ART. NO.
brushed	B0 5420238
polished	B0 5420239
Size	15 x 15 mm
Material	stainless steel
Length	451 mm

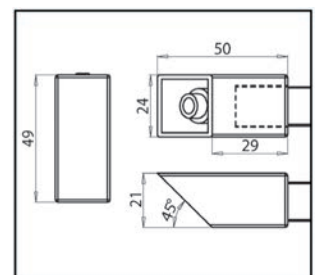
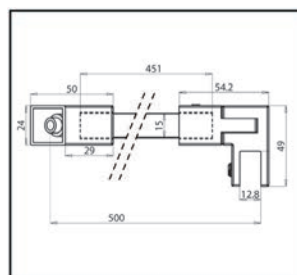

① Glass thickness 6, 8, 10 mm

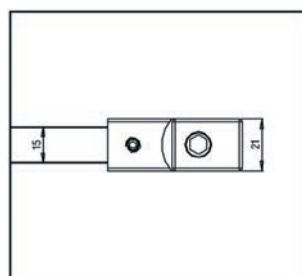
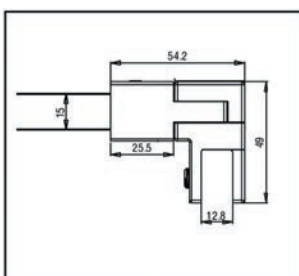

Wall Connector 90° Bohle square 15x15



FINISH	ART. NO.
brushed	B0 5420242
polished	B0 5420243
Size	15 x 15 mm
Material	stainless steel
Length	- mm

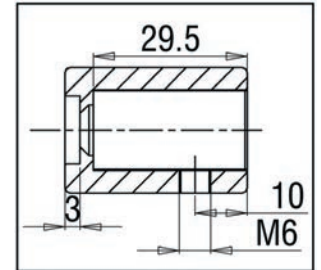
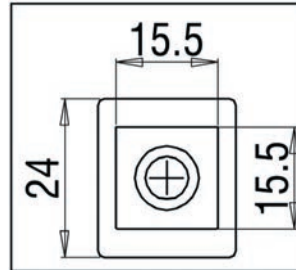

Wall Connector 45° Bohle square 15x15



FINISH	ART. NO.
brushed	B0 5420244
polished	B0 5420245
Size	15 x 15 mm
Material	stainless steel
Length	- mm

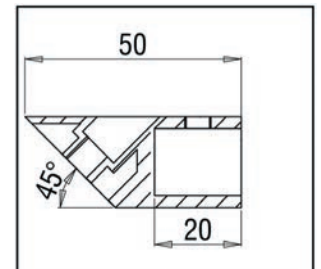
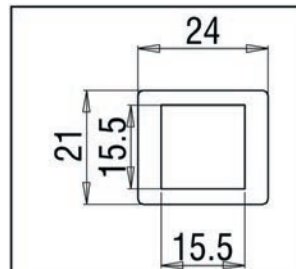

Wall connector adjustable 90° Bohle square 15x15

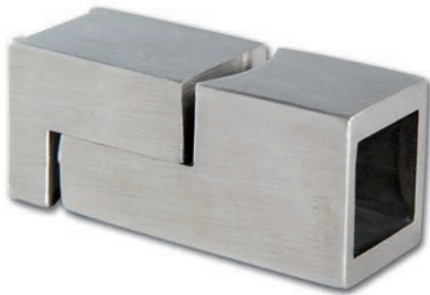

FINISH	ART. NO.
brushed	BO 5420246
polished	BO 5420247
Size	15 x 15 mm
Material	stainless steel
Length	- mm

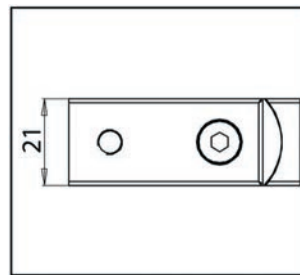
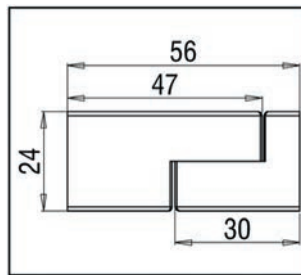
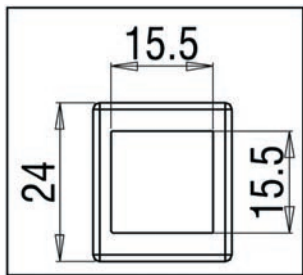

Connector 180° with Glass Connector Bohle square 15x15



FINISH	ART. NO.
brushed	BO 5420248
polished	BO 5420249
Size	15 x 15 mm
Material	stainless steel
Length	- mm

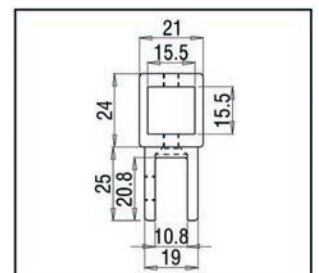
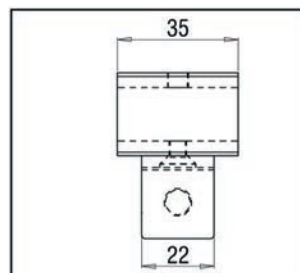

i Glass thickness 6, 8, 10 mm

Three-Point Connector Bohle square 15x15



FINISH	ART. NO.
brushed	BO 5420250
polished	BO 5420251
Size	15 x 15 mm
Material	stainless steel
Length	- mm

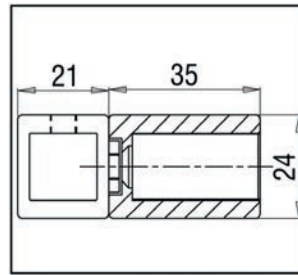
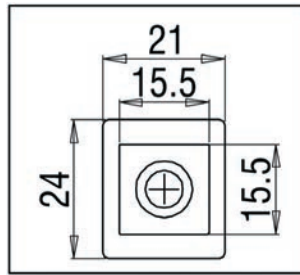
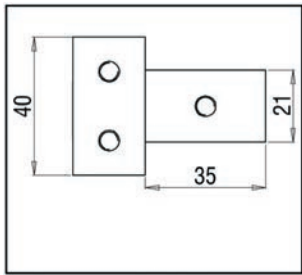

Corner Connector adjustable 90°-180° Bohle square 15x15



FINISH	ART. NO.
brushed	BO 5420252
polished	BO 5420253
Size	15 x 15 mm
Material	stainless steel
Length	- mm

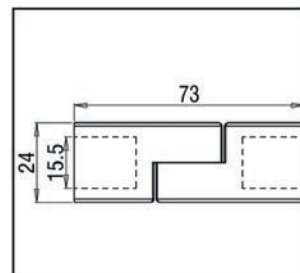
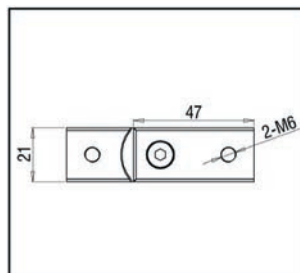
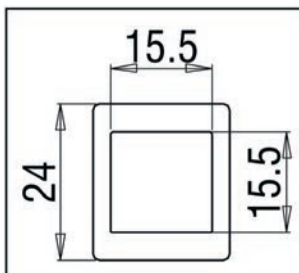

Corner Connector adjustable with Glass Connector Bohle square 15x15

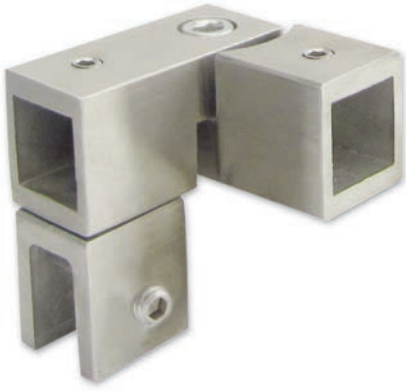

i Glass thickness 6, 8, 10 mm

FINISH	ART. NO.
brushed	BO 5420254
polished	BO 5420255
Size	15 x 15 mm
Material	stainless steel
Length	- mm

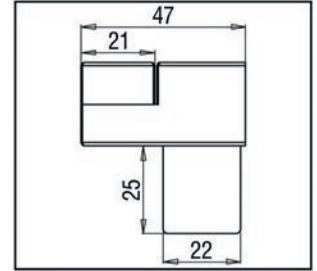
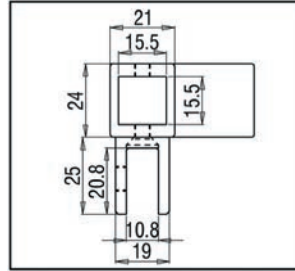

Glass Connector adjustable Bohle square 15x15



i Glass thickness 6, 8, 10 mm

FINISH	ART. NO.
brushed	BO 5420256
polished	BO 5420257
Size	15 x 15 mm
Material	stainless steel
Length	- mm

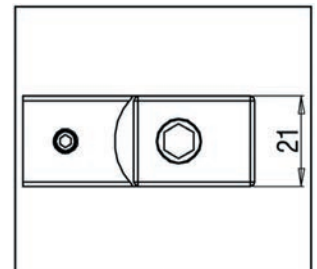
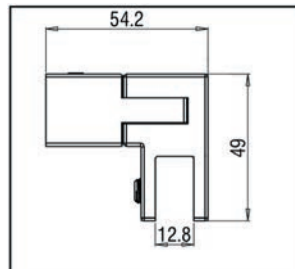

Reinforcement Bar Bohle square 15x15



FINISH · LENGTH	ART. NO.
brushed · 1000 mm	BO 5420258
polished · 1000 mm	BO 5420259
brushed · 2000 mm	BO 5420260
polished · 2000 mm	BO 5420261

Size	15 x 15 mm
Material	stainless steel

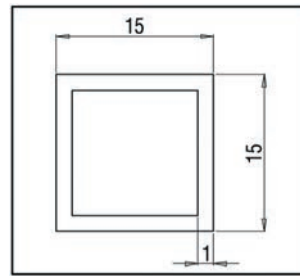

Bohle square 12 x 12 mm

Reinforcement Bar Set Bohle square 12x12 glass/wall 90°



i Bar can be trimmed to size · Adjustable wall connector · Concealed screws · Glass thickness 8, 10 mm

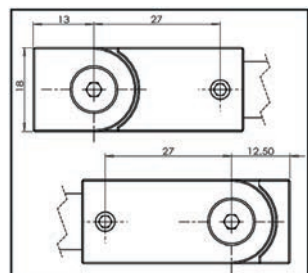

FINISH	ART. NO.
shiny chrome-plated	BO 5420262
Size	12 x 12 mm
Material	brass
Length	1210 mm

This product is also available in the on-trend colour black, please ask us!

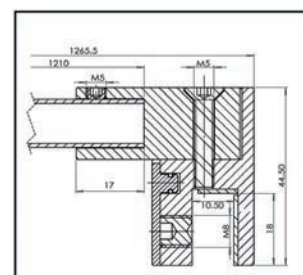
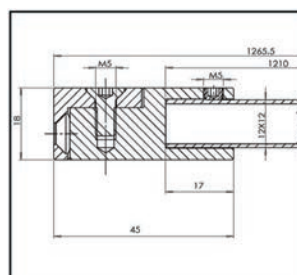

Through glass connector Bohle square 12x12



i Fixed with drill hole in glass · Glass thickness 8, 10, 12 mm

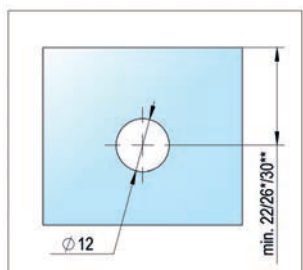

FINISH	ART. NO.
shiny chrome-plated	BO 5213679
Size	12 x 12 mm
Material	brass
Length	- mm

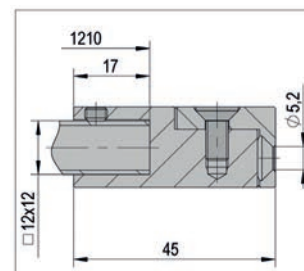
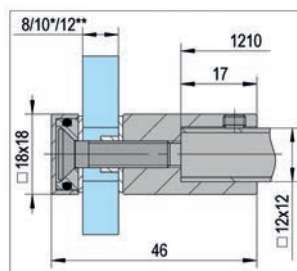

Bohle round

Easy to mount because reinforcement bars can be trimmed to any desired length. No cut-outs or drilled holes in the glass required. Glass holders are infinitely adjustable.

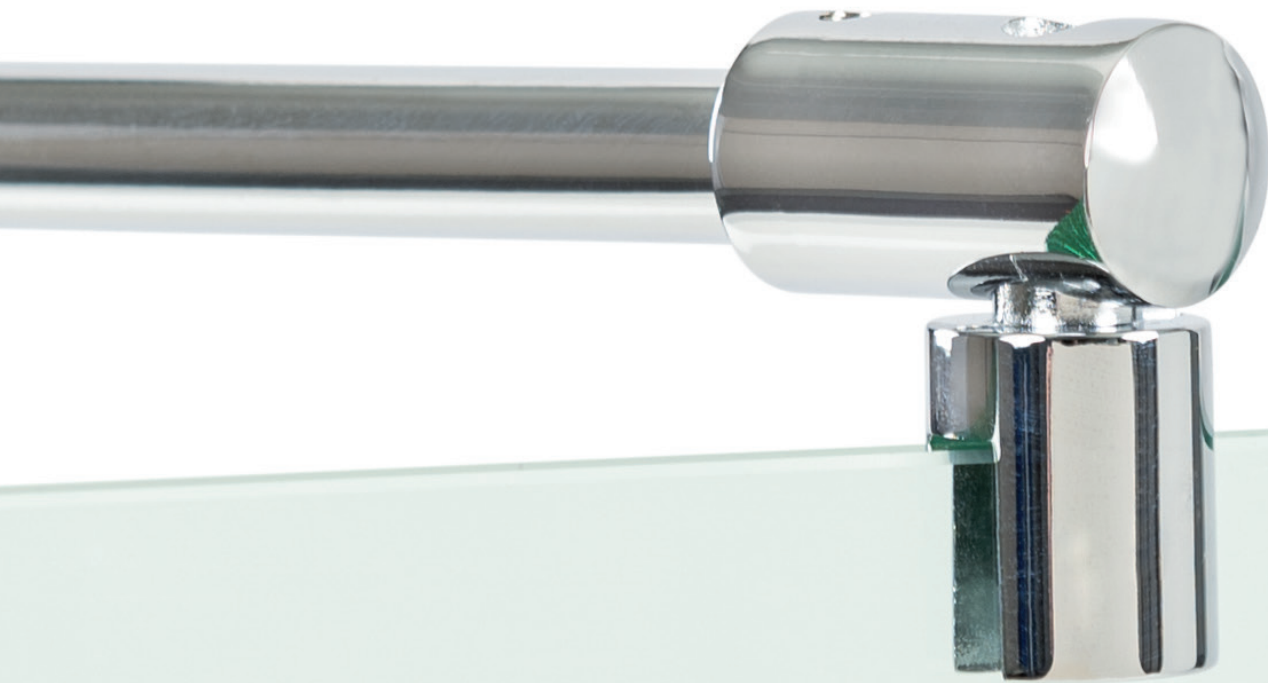

Bohle round \varnothing 12 mm

Reinforcement Bar Set Bohle round \varnothing 12 glass/wall 90°



i Bar can be trimmed to size · Adjustable wall connector · Glass thickness 8, 10 mm

FINISH	ART. NO.
shiny chrome-plated	BO 5420065
Size	\varnothing 12 mm
Material	brass
Length	1210 mm

This product is also available in the on-trend colour black, please ask us!

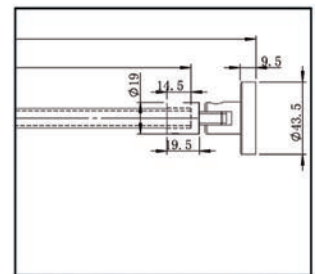
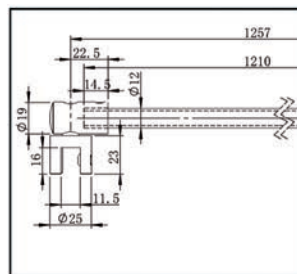

Wall Connector 90° Bohle round \varnothing 12



i Suitable for reinforcement Bar BO 5420065

FINISH	ART. NO.
shiny chrome-plated	BO 5420064
Size	\varnothing 12 mm
Material	brass
Length	- mm

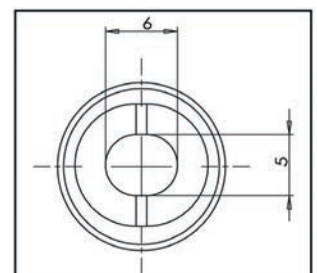
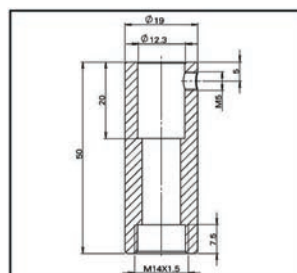

Bohle Telescopic round \varnothing 19 mm

Telescopic Reinforcement Bar Set Bohle round \varnothing 19 glass/wall 90°



FINISH · LENGTH	ART. NO.
shiny chrome-plated · 820 - 1000 mm	B0 5420211
shiny chrome-plated · 1000 - 1150 mm	B0 5420215

Size	\varnothing 19 mm
Material	brass

i Length adjustable · Glass thickness 6, 8, 10 mm · Bar can be trimmed to size

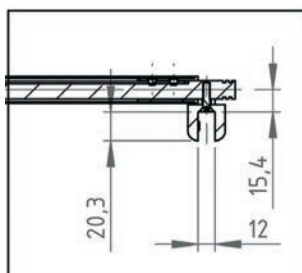
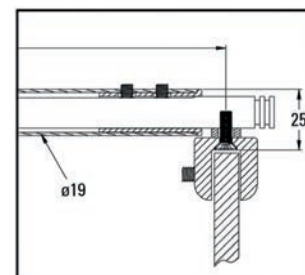
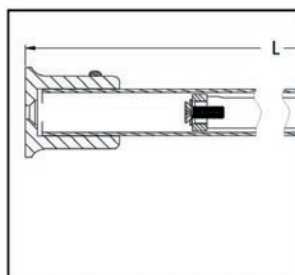

Telescopic Reinforcement Bar Set Bohle round $\varnothing 19$ glass/wall 45°



FINISH · LENGTH	ART. NO.
shiny chrome-plated · 240 - 400 mm	B0 5420221
shiny chrome-plated · 550 - 700 mm	B0 5420225
Size	$\varnothing 19$ mm
Material	brass

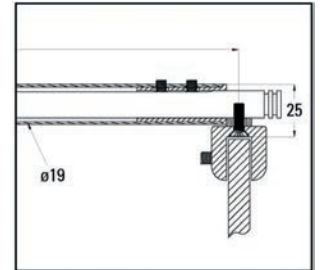
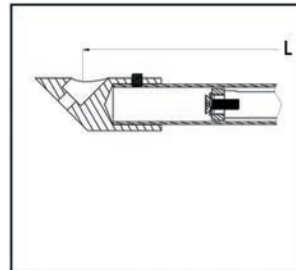

i Length adjustable · Glass thickness 6, 8, 10 mm · Bar can be trimmed to size

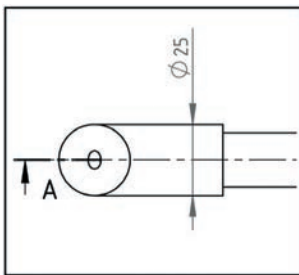

Telescopic Reinforcement Bar Set Bohle round $\varnothing 19$ glass/glass



FINISH	ART. NO.
shiny chrome-plated	B0 5420231
Size	$\varnothing 19$ mm
Material	brass
Length	750 - 1050 mm

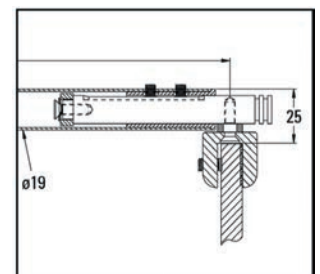
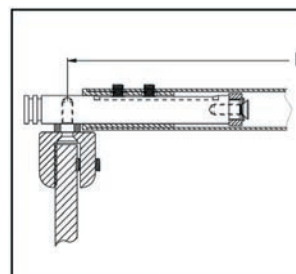

i Length adjustable · Glass thickness 6, 8, 10 mm



Shower door handles and knobs

Our wide range of knobs, handles and towel holders helps individualise your shower cubicle to your personal bathroom concept. Great value is attached to the choice of different materials, finishes, applications and shapes available.

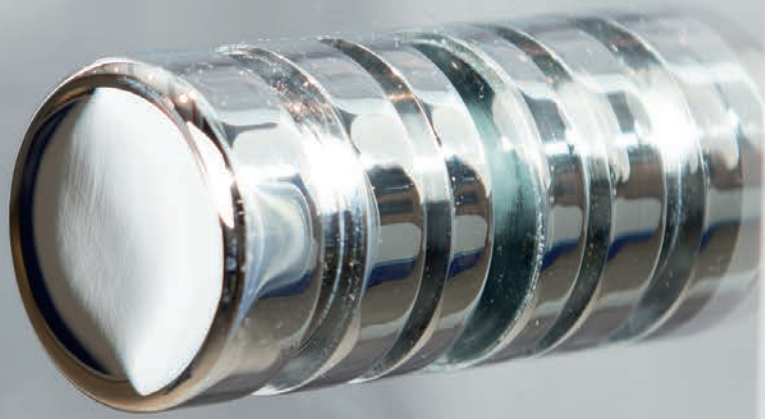

Shower Door Handle self-adhesive, single sided



FINISH · DEPTH	ART. NO.
brushed · (H) 17 mm	BO 5113720
polished · (H) 17 mm	BO 5113721
polished · (H) 8 mm	BO 5113723

Material	stainless steel
Width	(B) 12 mm
Height	(L) 150 mm

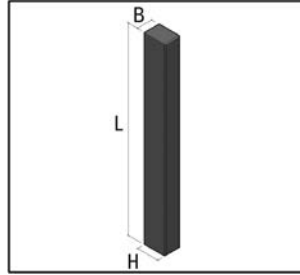

Shower Doorknob, both sides



FINISH	ART. NO.
shiny chrome-plated	BO 5213725

Material	brass
Width	ø30 mm
Height	– mm
Depth	50 mm

i Glass thickness tempered glass 6, 8, 10 mm · Drill hole in glass ø10 mm

Shower Doorknob, both sides



FINISH · MATERIAL	ART. NO.
shiny chrome-plated · brass	BO 5213705
stainless steel look · brass	BO 5213706
shiny chrome-plated · aluminium	BO 5213708
stainless steel look · aluminium	BO 5213709

Width	ø32 mm
Height	– mm
Depth	30 mm

This product is also available in the on-trend colour black, please ask us!

i Glass thickness tempered glass 6, 8, 10 mm · Drill hole in glass ø10 mm

Shower Doorknob, both sides



FINISH	ART. NO.
shiny chrome-plated	BO 5213715
stainless steel look	BO 5213716
Material	brass
Width	ø40 mm
Height	– mm
Depth	35 mm

i Glass thickness tempered glass 6, 8, 10 mm · Drill hole in glass ø10 mm

Shower Doorknob, both sides



FINISH	ART. NO.
shiny chrome-plated	BO 5213722
Material	brass
Width	ø30 mm
Height	– mm
Depth	30 mm

i Glass thickness tempered glass 6, 8, 10 mm · Drill hole in glass ø10 mm

Shower Doorknob Crystal Glass, both sides



FINISH	ART. NO.
transparent	BO 5213781
Material	Glass
Width	ø37 mm
Height	– mm
Depth	35 mm

i Glass thickness tempered glass 6, 8, 10 mm · Drill hole in glass ø12 mm